

ALL MODE HF TRANSCEIVER  
**DX-SR8**  
Instruction Manual

**ALINCO,INC.**

Head Office: Yodoyabashi-Dai Building 13th Floor  
4-9, 4-Chome, Koraiabashi, Chuo-ku, Osaka 541-0043, Japan  
Phone: +81-6-7636-2362 Fax: +81-6-6208-3802  
<http://www.alinco.com/>  
E-mail: [export@alinco.co.jp](mailto:export@alinco.co.jp)

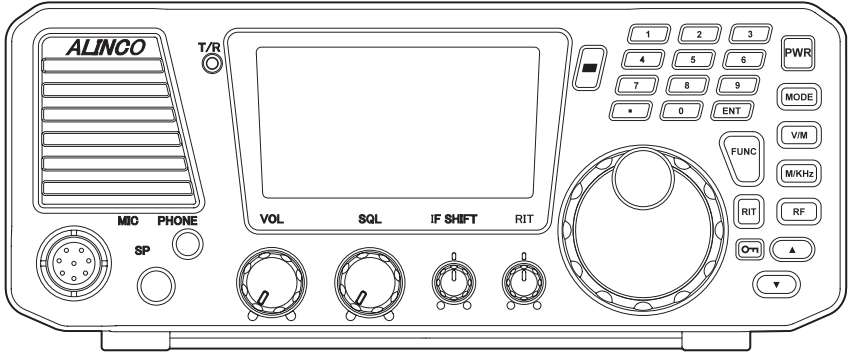

Thank you for purchasing your new ALINCO transceiver.  
This instruction manual (and addendum sheets) contains important safety and operating instructions.  
Please read this manual carefully before using the product and keep it for future reference.

# NOTICE / Compliance Information Statement

## Conformity Information

Alinco, Inc. Electronics Division hereby declares on our sole responsibility that the product(s) listed below comply with the essential requirements of the Directive 1999/5/EC, The council of 3/9/99 on Radio Equipment and Telecommunication Terminal Equipment and the mutual recognition of their conformity and with the provisions of Annex, after having performed the required measurements at Notified Bodies per Standards, and relative certificate(s) or document(s) can be reviewed at <http://www.alinco.com/Ce/> .

### **DX-SR8E**

SSB/CW/FM/AM HF TRANSCEIVER

European amateur radio bands between 1.8 MHz - 29 MHz as per specifications on page 94.



This device is authorized for use in all Eu and EFTA member states. An operator's license is required for this device.



Check with your local waste officials for details on recycling or proper disposal in your area.

**RoHS**

HF Transceiver DX-SR8T

The FCC Part 15 approval is not required for amateur-radio use of this device in USA/Canada.

Copyright © All rights reserved. No part of this document may be reproduced, translated or transcribed in any form or by any means without the prior permission of Alinco, Inc., Osaka, Japan, English Edition Printed in Japan.

# Contents

---

<b>Contents .....</b>	<b>1</b>
<b>WARNING .....</b>	<b>5</b>
ALERT .....	5
■ Environment and condition of use:.....	5
■ Handling this product:.....	6
■ About power-supply:.....	6
In case of emergency:.....	7
■ Maintenance .....	7
CAUTION .....	7
■ Environment and condition of use:.....	7
■ About transceiver .....	8
■ About power-supply .....	8
<b>Before Operating the Transceiver .....</b>	<b>9</b>
Attention .....	9
Notice to California resident users .....	9
The transceiver has no protection against lightning. ....	9
Limited Power Source.....	9
<b>Introduction.....</b>	<b>10</b>
<b>Chapter 1 Getting Started .....</b>	<b>11</b>
1.1 Features .....	11
DX-SR8 Features .....	11
1.2 Standard Accessories .....	12
Checking Accessories .....	12
1.3 Installation and Connection (For Base Station).....	13
Connection Diagram.....	13
Procedure.....	13
1.4 Installation and Connection (For Mobile Operation).....	16
Connection Diagram.....	16
Procedure.....	16
1.5 Controls, Connectors, and Display.....	18
Front Panel .....	18
Front Panel (keypad) .....	19
Rear Panel.....	21
Microphone.....	22
Display.....	23
<b>Chapter 2 Communications .....</b>	<b>25</b>
2.1 Reception Basics .....	25
Introduction.....	25
Procedure.....	25
Exercise.....	29
Direct Frequency Entry with Keypad .....	30
Getting Familiar with Useful Functions .....	31
2.2 Transmission Basics.....	33
Introduction.....	33
Procedure.....	33
2.3 SSB Operation .....	35
Introduction.....	35







Procedure.....	35
2.4 Practical Techniques for SSB Operation .....	36
Introduction.....	36
Eliminating Interference (QRM).....	36
Communicating in Bad Conditions .....	37
Communicating with Off-frequency Stations .....	37
Communicating in Pile-ups.....	37
2.5 AM Operation .....	38
Procedure.....	38
2.6 General Coverage Receiver Operation .....	39
Introduction.....	39
Procedure.....	39
2.7 FM Operation .....	41
Introduction.....	41
Procedure.....	41
2.8 Repeater Operation (QUICK OFFSET).....	42
Introduction.....	42
Procedure.....	42
2.9 CW Operation .....	43
Introduction.....	43
Procedure.....	43
2.10 Practical Techniques for CW Operation.....	44
Introduction.....	44
Reducing Interference .....	44
Communicating in Bad Conditions .....	44
Communicating in Pile-ups.....	44
2.11 Split-Frequency Operation .....	45
Introduction.....	45
Procedure.....	45
2.12 RTTY Packet Operation (FAX/SSTV).....	46
Introduction.....	46
Connecting Additional Equipment .....	46
Procedure.....	46
<b>Chapter 3 Memory Features.....</b>	<b>47</b>
3.1 Basics.....	47
Features .....	47
3.2 Simplex-VFO-Frequency Programming .....	48
Procedure.....	48
3.3 Split-Frequency Programming Using Quick Offset Function.....	49
Procedure.....	49
3.4 Split-frequency Programming.....	50
Procedure.....	50
3.5 Memory Mode Operation .....	51
Procedure.....	51
3.6 Memory Channel Data Erasing.....	52
Erasing Data in a Selected Memory Channel .....	52
Erasing All Memory Channels (Memory reset) .....	52
3.7 Memory To VFO Data Transfer .....	53
Introduction.....	53
Procedure.....	53
3.7 Channel Name (Alphanumeric) Registration Function.....	53

<b>Chapter 4 Scanning</b> .....	<b>55</b>
4.1 Basics.....	55
Introduction.....	55
Scan Types .....	55
Scanning conditions .....	57
4.2 Band Scan.....	58
4.3 Programmed Scan .....	59
4.4 Search Scan.....	59
4.5 Memory Scan.....	60
4.6 Skip-channel Setting .....	60
4.7 Priority Scan.....	61
<b>Chapter 5 Special Functions</b> .....	<b>62</b>
5.1 Interference Reducers.....	62
Introduction.....	62
IF SHIFT .....	62
Narrow Filter .....	63
CW BFO REVERSE.....	64
NB (Noise Blanker).....	64
5.2 Other Useful Functions .....	65
RIT/TXIT Function .....	65
$\pm\Delta f$ (Plus-Minus Delta F) Function.....	66
VFO A=B Function .....	66
MULTI FUNCTION Feature .....	67
DIAL LOCK Function.....	68
KEY LOCK Function.....	68
CABLE CLONE .....	69
<b>Chapter 6 Parameter Setting Mode (Set mode)</b> .....	<b>70</b>
A List of the Setting Mode Parameters.....	70
To Use the Parameter Setting Mode .....	70
Menu 00. Frequency Step of the [ $\blacktriangle$ / $\blacktriangledown$ ] Keys Setting.....	71
• SSB and CW Modes .....	71
• AM Mode.....	71
• FM Mode.....	72
Menu 01. Memory Overwrite Protection.....	72
Menu 02. Memory Frequency Access Protection.....	73
Menu 03. Timer SCAN Setting .....	73
Menu 04. Select Scan types.....	74
Menu 05. Search range setting for Search scan .....	75
Menu 06. Memory scan skip Setting .....	75
Menu 07. Dimmer.....	76
Menu 08. Beep Sound.....	76
Menu 09. Automatic USB/LSB Selection.....	77
Menu 10. Automatic AGC-S/AGC-F Selection .....	77
Menu 11. TXIT Function Setting.....	78
Menu 12. Electronic Keyer Setting .....	78
Menu 13. Electronic Keyer Speed Setting.....	78
Menu 14. Electronic Keyer Reverse Setting .....	79
Menu 15. Sidetone (CW Offset) Setting.....	79
Menu 16. Break-in Delay Time for CW operation .....	79
• AT (AUTO).....	80

- 1 to 7 ..... 80
- FL (FULL)..... 80
- Menu 17. Key ratio ..... 80
- Menu 18. CTCSS Tone Encoding Setting ..... 81
- Menu 19. Speech Compressor..... 81
- Menu 20. PTT Key Lock ..... 82
- Menu 21. APO-Auto Power OFF ..... 82
- MENU 22. UP/DOWN keys function setting ..... 83
- MENU 23. FUNC key resume timing setting ..... 83
  
- Chapter 7 Maintenance..... 84**
- 7.1 Adjustment ..... 84
  - Introduction..... 84
  - Adjustment Item List..... 84
  - Removing the FRONT unit ..... 84
  - Removing the Covers ..... 84
  - Procedure..... 85
- 7.2 Fuse replacement ..... 86
  - DC POWER CABLE FUSE REPLACEMENT ..... 86
  - CIRCUITRY FUSE REPLACEMENT..... 86
- 7.3 Reset..... 87
  - Procedure..... 87
- 7.4 Cleaning ..... 87
- 7.5 Troubleshooting ..... 88
  
- Appendix ..... 90**
- Options..... 90
- About Mounting Bracket and Carrying Handle ..... 91
- External Antenna Tuner (Optional) ..... 92
  - ALINCO EDX-2 ..... 92
- Specifications..... 93









# WARNING



To prevent any hazard during operation of Alinco's radio product, in this manual and on the product you may find symbols shown below. Please read and understand the meanings of these symbols before starting to use the product.

 Danger	This symbol is intended to alert the user to an immediate danger that may cause loss of life and property if the user disregards the warning.
 Alert	This symbol is intended to alert the user to a possible hazard that may cause loss of life and property if the user disregards the warning.
 Caution	This symbol is intended to alert the user a possible hazard that may cause loss of property or injure the user if the warning is disregarded.
	Alert symbol. An explanation is given.
	Warning symbol. An explanation is given.
	Instruction symbol. An explanation is given.





## ALERT

### ■ Environment and condition of use:







-  Do not drive while handling the radio for your safety. It is recommended that you check local traffic regulations regarding the use of radio equipment while driving. Some countries prohibit the operation of transceiver while driving.
-  Do not use this product in close proximity to other electronics devices, especially medical ones. It may cause interference to those devices.
-  Keep the radio out of the reach of children.
-  In case a liquid leaks from the product, do not touch it. It may damage your skin. Rinse with plenty of cold water if the liquid contacted your skin.
-  Never operate this product in facilities where radio products are prohibited for use such as aboard aircraft, in airports, in ports, within or near the operating area of business wireless stations or their relay stations.
-  Use of this product may be prohibited or illegal outside of your country. Be informed in advance when you travel.
-  The manufacturer declines any responsibilities against loss of life and/or property due to a failure of this product when used to perform important tasks like life-guarding, surveillance, and rescue.
-  Do not use multiple radios in very close proximity. It may cause interference and/or damage to the product(s).

-  Risk of explosion if battery is replaced with an incorrect type. Dispose of, or recycle used batteries according to your local regulations.
-  The manufacturer declines any responsibilities against loss of life and property due to a failure of this product when used with or as a part of a device made by third parties.
-  Use of third party accessory may result in damage to this product. It will void our warranty for repair.

■ **Handling this product:**

-  Be sure to reduce the audio output level to minimum before using an earphone or a headset. Excessive audio may damage hearing.
-  Do not open the unit without permission or instruction from the manufacturer. Unauthorized modification or repair may result in electric shock, fire and/or malfunction.
-  Do not operate this product in a wet place such as shower room. It may result in electric shock, fire and/or malfunction.
-  Do not place the product in a container carrying conductive materials, such as water or metal in close proximity to the product. A short-circuit to the product may result in electric shock, fire and/or malfunction.
-  Do not touch the heatsink (on/around the unit mostly found on mobile-base units) as it may become very hot during/after the operation that may risk burn your skin.

■ **About power-supply:**

-  Use only appropriate, reliable power supply of correct voltage and capacity.
-  Do not connect cables in reverse polarity. It may result in electric shock, fire and/or malfunction.
-  Do not plug multiple devices including the power-supply into a single wall outlet. It may result in overheating and/or fire.
-  Do not handle a power-supply with a wet hand. It may result in electric shock.
-  Securely plug the power-supply to the wall outlet. Insecure installation may result in short-circuit, electronic shock and/or fire.
-  Do not plug the power-supply into the wall socket if the contacts are dirty. Shortcircuiting and/or overheating may result in fire, electric shock and/or damage to the product.
-  Do not modify or remove fuse-assembly from the DC-cable. It may result in fire, electric shock and/or damage to the product.



## In case of emergency:

In case of the following situation(s), please turn off the product, switch off the source of power, then remove or unplug the power-cord. Please contact your local dealer of this product for service and assistance. Do not use the product until the trouble is resolved. Do not try to troubleshoot the problem by yourself.

- When a strange sound, smoke and or strange odor comes out of the product.
- When the product is dropped or the case is broken or cracked.
- When a liquid penetrated inside.
- When a power-cord ( including DC-cables, AC-cables and adapters) is damaged.

 For your safety, turn off then remove all related AC-lines to the product and its accessories from the wall outlet if a thunderstorm is likely.

 Turn off the unit, remove the mobile antenna from its base and keep it in the vehicle if a thunderstorm is likely.  
Please read cautions regarding the lightning-protection on page 7 also.

## ■ Maintenance

 Do not open the unit and its accessories. Please consult with your local dealer of this product for service and assistance.

## CAUTION

### ■ Environment and condition of use:

 Do not use the product in proximity to a TV or a radio. It may cause interference or receive interference.





 Do not install in a humid, dusty or insufficiently ventilated place. It may result in electric shock, fire and/or malfunction.

 Do not install in an unstable or vibrating position. It may result in electric shock, fire and/or malfunction when/if the product falls to the ground.





 Do not install the product in proximity to a source of heat and humidity such as a heater or a stove. Avoid placing the unit in direct sunlight.

 Do not modify, dismantle, incinerate, or immerse the batteries.  
Please check your local regulations for details on recycling option or disposal of the batteries in your area.

### ■ About transceiver

-  Do not connect devices other than specified ones to the jacks and ports on the product. It may result in damage to the devices.
-  Turn off and remove the power-source (AC cable, DC cable, battery, cigar-cable, charger adapter etc) from the product when the product is not in use for extended period of time or in case of maintenance.
-  Never pull the cord alone when you unplug AC cable from the wall outlet.
-  Use a clean, dry cloth to wipe off dirt and condensation from the surface of the product. Never use thinner or benzene for cleaning.

### ■ About power-supply

-  Use only reliable power supply of specific DC output range and be mindful of the polarity of the cables and DC jack.
-  Always turn off the power supply when connecting or disconnecting the cables.
-  When using an external antenna, make sure that the antenna ground is not common with the ground of the power supply.
-  European users: When a transceiver is powered from an external DC power source (adapter, power supply, cigar-plug etc), make sure that this power supply has approval to the level of IEC/EN 60950-1.

# Before Operating the Transceiver

---

## Attention

- Do not remove the case or touch the interior components. Tampering can cause equipment trouble.
- Do not use or keep the transceiver where it is exposed to direct sunlight, dusty places, or near sources of heat.
- Keep the transceiver away from TV's or other equipment when it interferes with reception.
- When transmitting for long periods of time at high power, the transceiver might overheat.
- Turn the power off immediately if the transceiver emits smoke or strange odors. Ensure the transceiver is safe, then bring it to the nearest Alinco service center.
- An operator's license is required for this device.

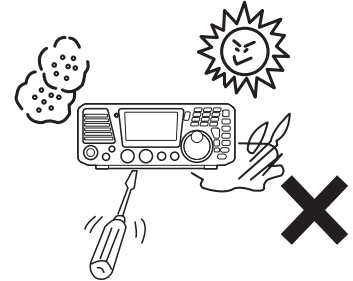

## Notice to California resident users

The product that comes with this manual is free from dangerous material such as lead and cadmium as per RoHS order of EU.

## The transceiver has no protection against lightning.

The user is responsible for providing adequate protection if he uses the device at home and installs the antenna outdoor. Be aware that any outdoor antenna creates a direct path for lighting current (more than 10kA) to the transceiver. This path exists whether the device is turned ON or OFF.

Any vehicle does not present a safe environment during lightning. This environment becomes much more dangerous if an outdoor antenna is installed on the car. Move the antenna and its cable into the car at the first sight of forthcoming thunderstorm and lightning.

## Limited Power Source

Please note that the transceiver enclosure only provides mechanical protection for its internal parts; it will not contain a fire within the device if the fire starts under certain fault conditions. Alinco will not take responsibility for any fire hazard associated with powering the transceiver or charging its batteries using a power source that does not belong to the limited power source in the meaning of EN60950-1.

# Introduction

---

Thank you very much for purchasing this excellent Alinco transceiver. Our products are ranked among the finest in the world. This radio has been manufactured with state of the art technology and it has been tested carefully at our factory. It is designed to operate to your satisfaction for many years under normal use.

PLEASE READ THIS MANUAL COMPLETELY TO LEARN ALL THE FUNCTIONS THE PRODUCT OFFERS. WE MADE EVERY ATTEMPT TO WRITE THIS MANUAL TO BE AS COMPREHENSIVE AND EASY TO UNDERSTAND AS POSSIBLE. IT IS IMPORTANT TO NOTE THAT SOME OF THE OPERATIONS MAY BE EXPLAINED IN RELATION TO INFORMATION IN PREVIOUS CHAPTERS. BY READING JUST ONE PART OF THE MANUAL, YOU RISK NOT UNDERSTANDING THE COMPLETE EXPLANATION OF THE FUNCTION.

# Chapter 1 Getting Started

---

## 1.1 Features

### DX-SR8 Features

#### **DX-SR8**

Covers HF (1.8 MHz to 28 MHz) amateur radio bands in SSB, AM, FM, and CW modes.

#### **General coverage receiver**

Covers 135 kHz to 30 MHz in all modes.

#### **Direct frequency input**

Provided with numerical keys to input frequency directly without using the dial.

#### **Front control unit separation with the optional EDS-17**

Completely detachable front control panel with large LCD.

#### **Front speaker**

Powerful and clear audio with 2 W Audio Amplifier.

#### **Front jacks**

Connecting easily with an external speaker and headphones.

#### **Versatile interference eliminators**

The IF SHIFT function; Built-in audio filter as standard for CW; and RF attenuator, all effectively help to reject unwanted signals.

#### **Powerful CW operation with internal electronic keyer**

Enables you to receive CW signals from either the upper or lower side of the carrier frequency.

Selectable sidetone and pitch, FULL BREAK-IN (QSK), SEMI BREAK-IN (7 steps), and AUTO BREAK-IN (delay time automatically adjusted with keying speed).

#### **600 memory channels**

A total of 600 channels can be registered in three banks: 200 channels per bank.

Each stores mode, filter, split frequencies, AGC, attenuator (or pre-amp), noise-blanker settings and more.

#### **Computer control**

The DX-SR8 can be controlled by a personal computer through the serial interface.

Settings of frequency, mode, power, and memory channel can be controlled.

(Optional PC interface cable required)

## 1.2 Standard Accessories

### Checking Accessories

Carefully unpack to make sure the following items are found in the package.

- Transceiver

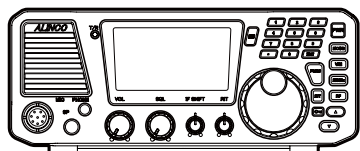

- Microphone EMS-53 (DX-SR8)  
EMS-64 (DX-SR8T/E)

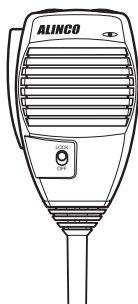

- DC power cable with fuse holder (UA0083)  
With spare fuses (2 pcs.)

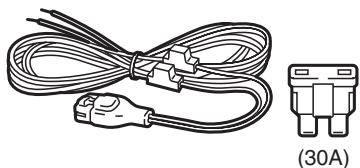

- Mic Hanger Unit  
Mic Hanger (EBC-7)



- Tapping screws  
(M3.5×10 mm) 2pcs.  
(AJ0025) for EBC-7



- Instruction manual  
(PS0610)

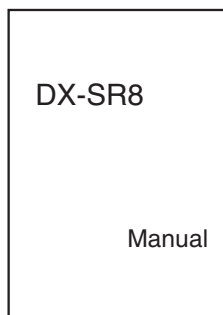

[Spare-part / pre-installed]

- Standard front unit cable used between main  
and front units.  
(UX1412)

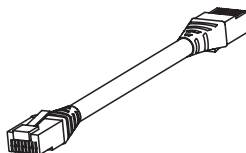

The standard accessories may vary slightly depending on the version you have purchased. Please contact your local authorized Alinco dealer should you have any questions. ALINCO and authorized dealers are not responsible for any typographical errors there may be in this manual. Standard accessories may change without notice.

#### Warranty Policy:

Please refer to any enclosed warranty information or contact your authorized Alinco dealer/distributor for the warranty policy before purchase.

## 1.3 Installation and Connection (For Base Station)

### Connection Diagram

This diagram shows the connections for a base station.

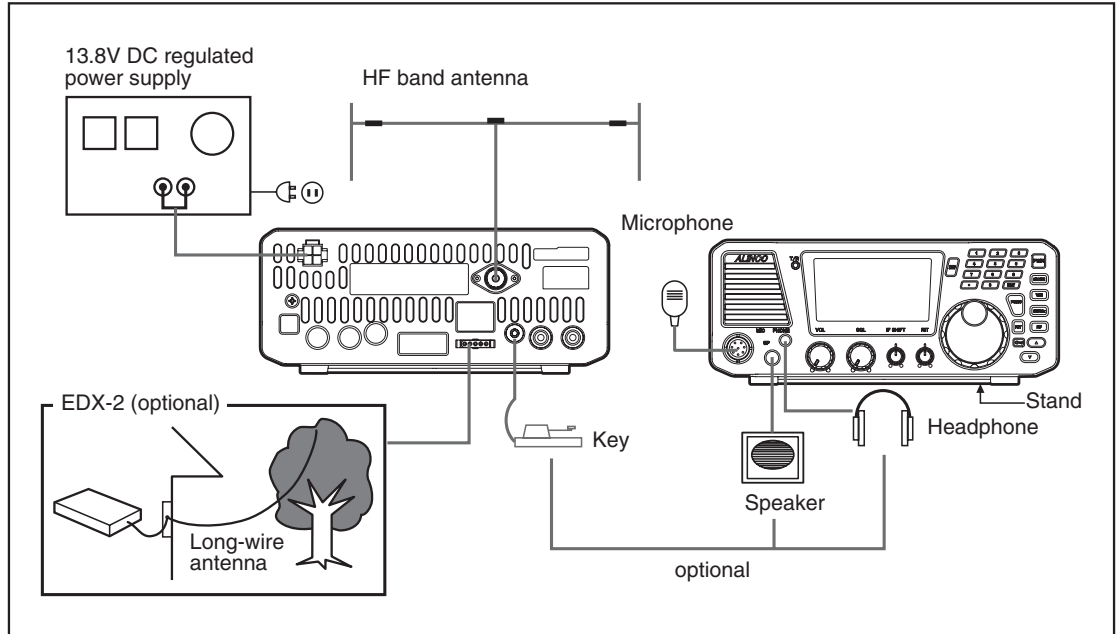

### Procedure

#### 1. Connecting an antenna and ground cable

- Antenna connection

Use a properly-adjusted (low SWR) antenna to obtain optimum performance from the transceiver. A 50 ohm impedance coaxial with PL-259 connector is required for this connection.

**NOTE:** It is recommended to use an optional automatic antenna tuner (EDX-2) for proper antenna matching.

- Ground connection

To prevent electric shock hazard and audio interference with other electronic appliances, bury a copper rod or plate under the ground and connect it to the transceiver GND terminal. Use a heavy gauge, short cable for this connection.

**IMPORTANT:** Do not ground the equipment on gas pipes, electrical conduits, or plastic water pipes.

## 2. Connecting a telegraph key

Connect a 3.5 mm diameter stereo plug to the KEY jack on the rear panel. If using an electronic-keyer, pay attention to the polarity of the plug.

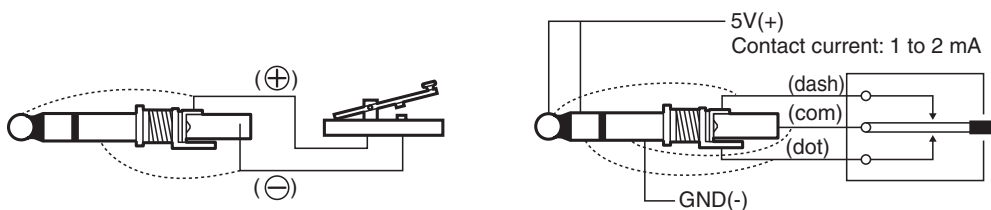

When connecting a straight key

When connecting a paddle

## 3. Connecting an external speaker (if not using the internal speaker)

Connect a 3.5 mm diameter mono plug to the SPEAKER jack on the front panel. Use a 3 W or higher external speaker with 8 ohm impedance.

**NOTE:** When an external speaker is used, no sound is heard from the internal speaker.

## 4. Connecting headphones

Connect a 3.5 mm diameter mono or stereo plug to the PHONES jack on the front panel.

**NOTE:** When headphones are used, no sound is heard from the speaker.

## 5. Connecting a regulated DC power supply

The Transceiver requires a 12-13.8VDC negative grounded power source. Use a regulated power supply capable of providing continuous current of 30A or more. Power supplies that do not meet those specifications may cause malfunction and/or damage to the radio and will void the warranty. Alinco offers excellent communication-grade power supplies as optional accessories. Please contact your local authorized Alinco dealer.

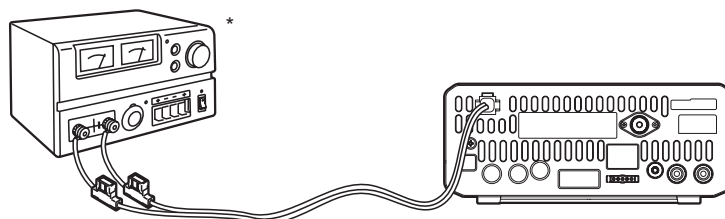

Red to positive  
Black to negative

**IMPORTANT:** Before connecting, be sure to turn off the transceiver and DC power supply.

\* When a transceiver is powered from an external DC power source, make sure that this power supply has approval to the level of IEC/EN 60950-1.



## 6. Installing the control panel and body separately

**IMPORTANT:** Be sure to disconnect the power cable before carrying out this procedure.

1. Remove 2 screws above the main unit to separate the front-control panel. Disconnect the cable

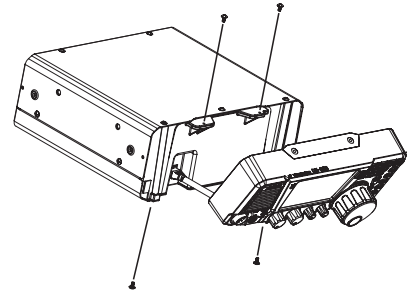

2. Remove other 2 screws at the bottom of the main unit.

3. Passing the separate-cable (5m) through the hole of the cover in advance, connect the cable to the main unit.

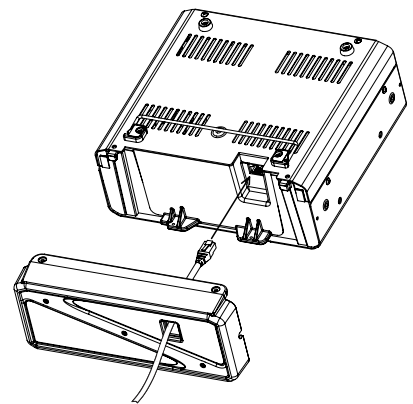

4. Fix the cover to the main unit using those 4 screws.

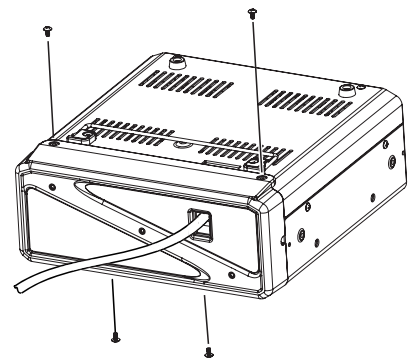

5. Fix the bracket using provided hardware, and connect another end of the cable to the front-control panel.

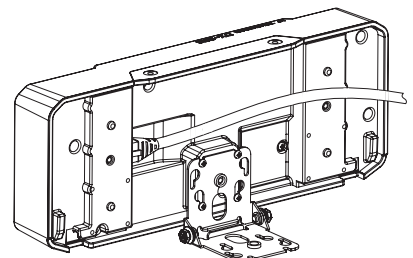

**NOTE:** Please be sure to keep the short, original cable in order to make it back to the original condition in future. Provided ferrite-beads on the separate cable are to eliminate the RF feed back. The position of beads may affect to the condition of RF feed back. See page 89 for troubleshooting.

## 1.4 Installation and Connection (For Mobile Operation)

### Connection Diagram

This diagram shows the connections for mobile operation.

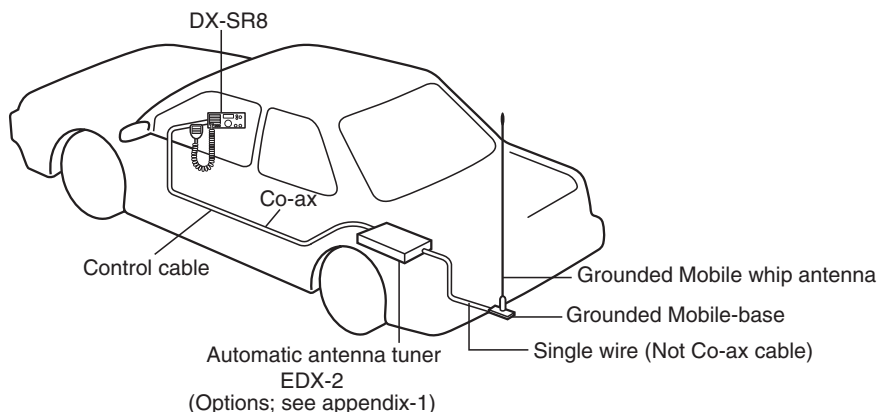

### Procedure

#### 1. Installing an antenna

Use a properly-adjusted (low SWR) antenna to obtain optimum performance.

1. Secure a commercially-available antenna base in a proper position on your car.
2. Ground the antenna base if necessary.

**IMPORTANT: A ground is indispensable for most HF antennas.**  
Please refer to the instruction of the antenna before installation.

3. Connect the antenna and transceiver using an appropriate cable that the antenna system requires.

**IMPORTANT: After installing your antenna, ensure that you have the best possible SWR reading.**  
High RF environments can cause severe damage to your unit. Ensure that you are not in a high RF environment when operating the transceiver.

**IMPORTANT: RF Hazard Warning**  
The electro-magnetic (radio Frequency) exposure level of this device may exceed the European standards of the hazard level when transmitting at the high-power setting while connected to a unity gain antenna at a distance of 63cm or less from the operator. Furthermore, the hazardous RF exposure level depends on the conditions of the combination of the antenna gain, distance from the operator, output setting and installation environment, therefore the operator may be exposed to stronger RF even at a distance of more than 63cm. For safety purpose, it is recommended that the antenna be installed outside of, and as far as possible from, the operator's area. Avoid using an excessively high-gained antenna in case the distance between the operator and the antenna is very limited. Always use the minimum necessary output power for communications.

## 2. Connecting the power cable

**IMPORTANT:** Use a 12 V car battery to operate the transceiver.

1. Connect the supplied power cable directly to the car battery.

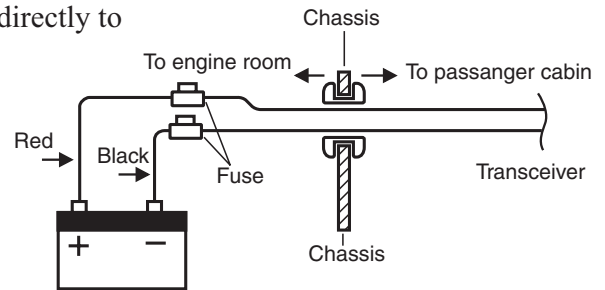

**NOTE:** If threading the cable through wiring holes, use grommets to prevent the cable from coming in contact with the car chassis.

**IMPORTANT:**

- If using a 24 V car battery, be sure to convert the voltage to 12 V DC with a DC/DC converter.
- Never connect the power cable to a cigarette lighter connector because the available current is too low.

## 3. Connecting the accessories

Please refer to:

- Microphone, page 20
- Telegraph key, page 14
- External speaker, page 14

## 4. Installing the control panel and body separately (optional)

To detach the control panel from the body, refer to P.15.

Install the control panel in a location that is easily accessible using the separate angle bracket, and be sure as well to install the body in a proper location, such as under a seat.

**IMPORTANT:**

- Be sure to disconnect the power cable before detaching the control panel from the body.
- Give the first priority to the safety of driving. Do not install anything that could obstacle the controls of your vehicle in driver's area.
- Mounting antenna and other accessories outside of your vehicle may be prohibited or restricted in some countries. Please check your local regulations before the installation.

# 1.5 Controls, Connectors, and Display

## Front Panel

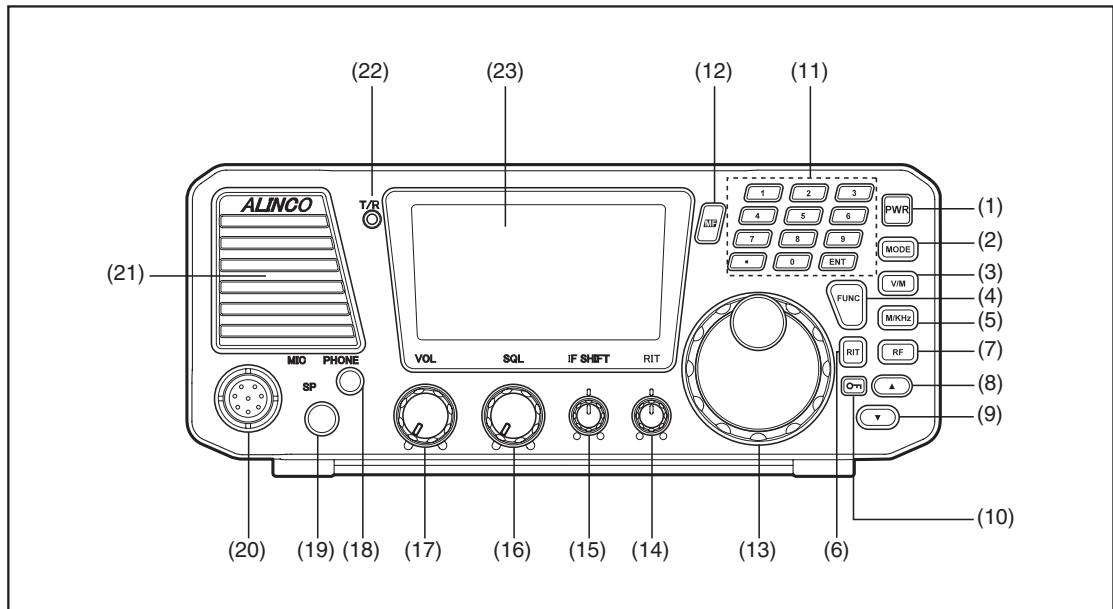

No.	Key	Principal Function
(1)	POWER SWITCH [PWR]	Turns the power on/off.
(2)	[MODE] key	Press to select the USB, LSB, CWU, CWL, AM, or FM modes.
(3)	[V/M] key	Switches between VFO mode and memory mode.
(4)	[FUNC] key	Press and hold this key for 1 second to access the Set mode.
(5)	[M/KHz] key	Switches the cursor position between MHz and kHz.
(6)	[RIT] key	Press to turn the RIT or TXIT function on/off.
(7)	[RF] key (pre-amplifier/attenuator)	Press to adjust receiver's front-end gain by switching between the pre-amplifier and attenuator. Pressing this key will change gains as follows: +10 dB, 0 dB, -10 dB, and -20 dB. After pressing the [FUNC] key, press this key to select a narrow filter in the SSB, CW and AM mode.
(8)	[▲] key	Press to select memory channels and amateur radio bands, and to change frequency in 1 MHz and 100 kHz increments. Also used to select the transceiver's settings in the Set mode.
(9)	[▼] key	Press to select memory channels and amateur radio bands, and to change frequency in 1 MHz and 100 kHz decrements. Also used to select the transceiver's settings in the Set mode.
(10)	[🔒] key	Enables the dial and key locks.
(11)	KEYPAD	The keypad can be used for several functions as described later.
(12)	MULTI FUNC [MF] key	Press to access the multifunction.
(13)	MAIN tuning dial	Rotate to select transmit/receive frequencies.
(14)	RIT control knob [RIT]	Fine-tunes the reception frequency within a range of ±1.2 kHz.
(15)	IF SHIFT control knob [IF SHIFT]	Rotate to eliminate the interference by shifting the receiver IF pass band (±1.5 kHz).
(16)	SQL control knob [SQL]	Rotate to eliminate noise when no signal is received.
(17)	AF gain control knob [VOL]	Rotate to adjust audio level.

No.	Key	Principal Function
(18)	PHONE jack [PHONE]	For connecting external headphones. Takes 8 to 32 ohm impedance headphones.
(19)	SPEAKER jack [SP]	For connecting an external speaker. Takes 8 to 16 ohm impedance speakers. Connect optional ERW-4C or ERW-7 cable for PC-interface.
(20)	Microphone connector [MIC]	For connecting a microphone.
(21)	Internal Speaker	Received signals are heard from here.
(22)	TX/RX LED	Lights red when transmitting the signal. Lights green when signals are received or squelch is open (unmuted).
(23)	LCD Display	Shows operating and setting information.

### Front Panel (keypad)

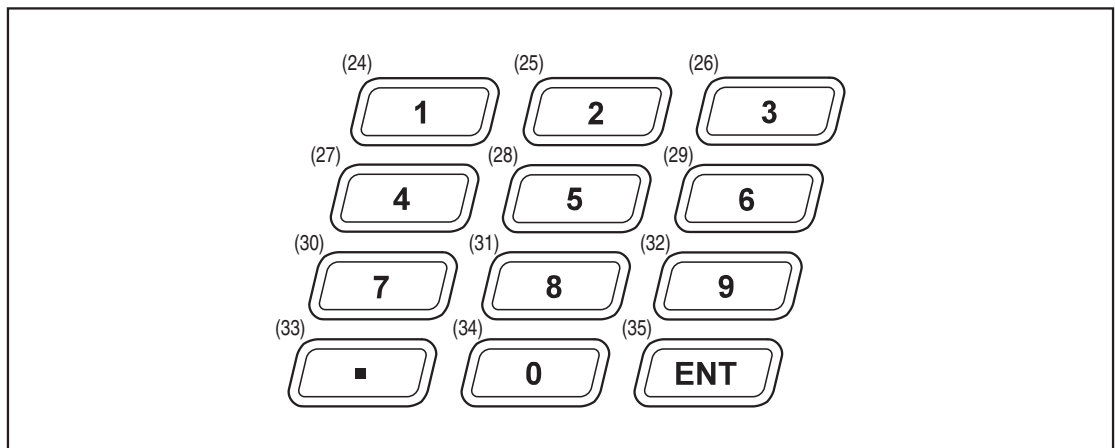

No.	Key	Function
(24)	1	To recall 1.8 MHz Band (Freq. direct input 1)
(25)	2	To recall 3.5 MHz Band (Freq. direct input 2)
(26)	3	To recall 5.3 MHz Band* (Freq. direct input 3)
(27)	4	To recall 7 MHz Band (Freq. direct input 4)
(28)	5	To recall 10 MHz Band (Freq. direct input 5)
(29)	6	To recall 14 MHz Band (Freq. direct input 6)
(30)	7	To recall 18 MHz Band (Freq. direct input 7)
(31)	8	To recall 21 MHz Band (Freq. direct input 8)
(32)	9	To recall 24 MHz Band (Freq. direct input 9)
(33)	.	Enters a frequency direct input 100 kHz (Freq. direct input decimal)
(34)	0	To recall 28 MHz Band (Freq. direct input 0)
(35)	ENT	Enters a frequency direct input

\* 5 channels allocated to the amateur-radio services can be transmitted on T version.  
Please refer Page 94 for details.

### Connecting the Microphone

1. Plug the microphone into the microphone connector on the body.

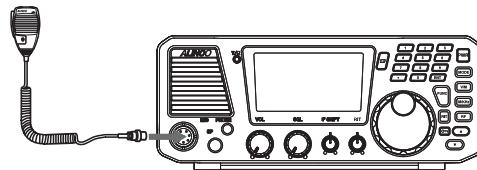

2. Tighten the screw on the connector to secure the connection.

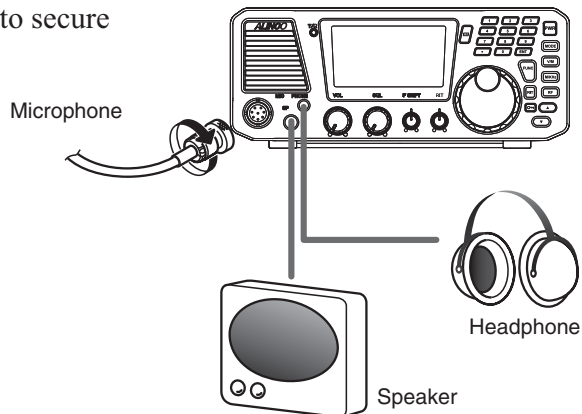

**NOTE:** Please be sure that the connector is securely tightened, and check the connection from time to time. Loose connection may cause noise on TX signals.

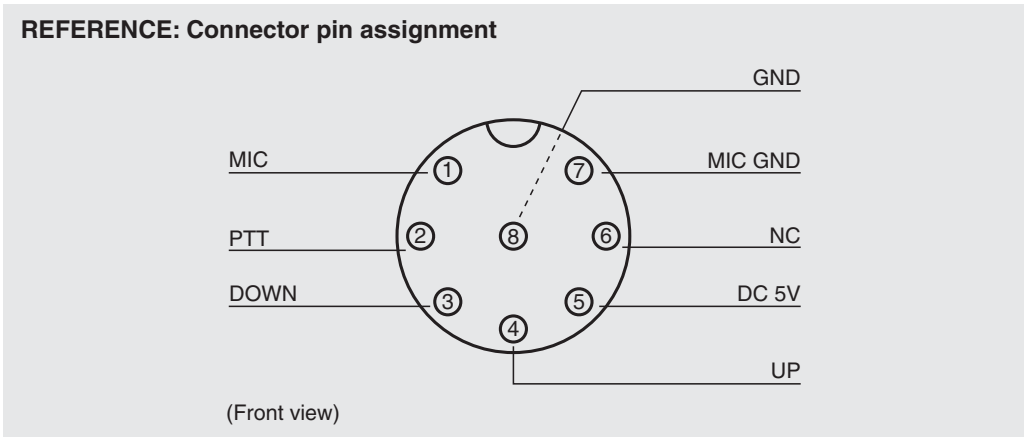

## Rear Panel

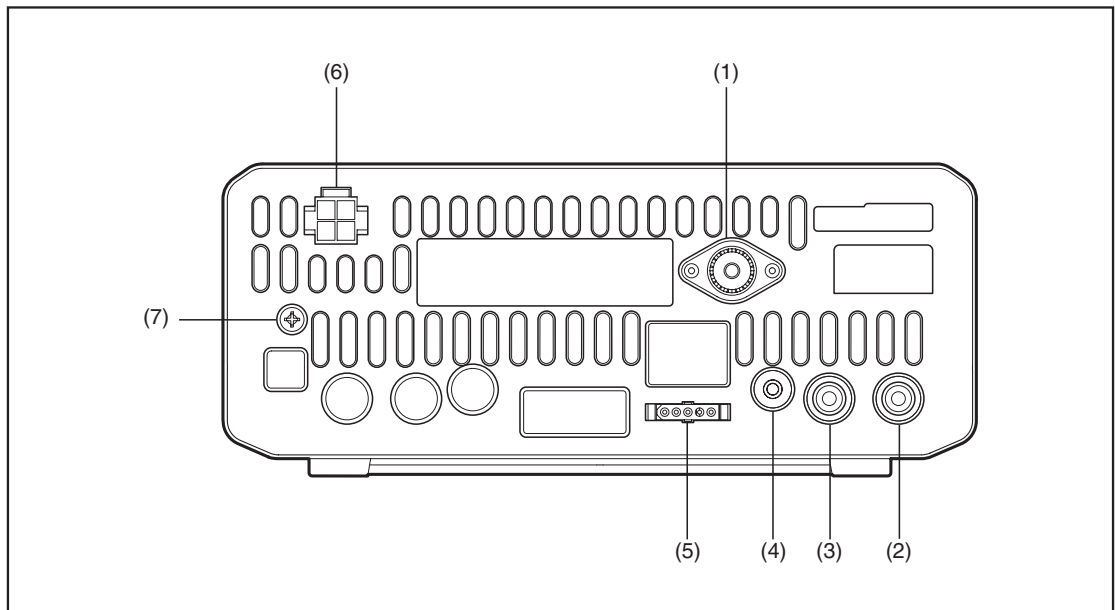

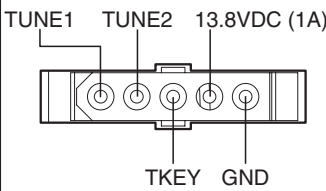
No.	Key	Function
(1)	ANTENNA connector	For connecting an HF band antenna. Takes a 50 ohm impedance coaxial cable with PL-259 connector.
(2)	RELAY (external relay) jack	For connecting external equipment such as a linear amplifier for switching between reception and transmission. Takes a phono-plug.
(3)	External ALC input jack	For connecting the phono-plug from the amplifier ALC circuit when a linear amplifier is used. The ALC input voltage must be from 0 to -3 V DC.
(4)	CW-KEY jack	For connecting a telegraph key or manipular paddle for internal electronic-keyer
(5)	ACC (accessory) connector	For connecting optional EDX - 2 antenna tuner. [Pin configuration] 
(6)	Power connector	For connecting the supplied DC power cable.
(7)	GND (ground) terminal	For connecting a ground cable.

## Microphone

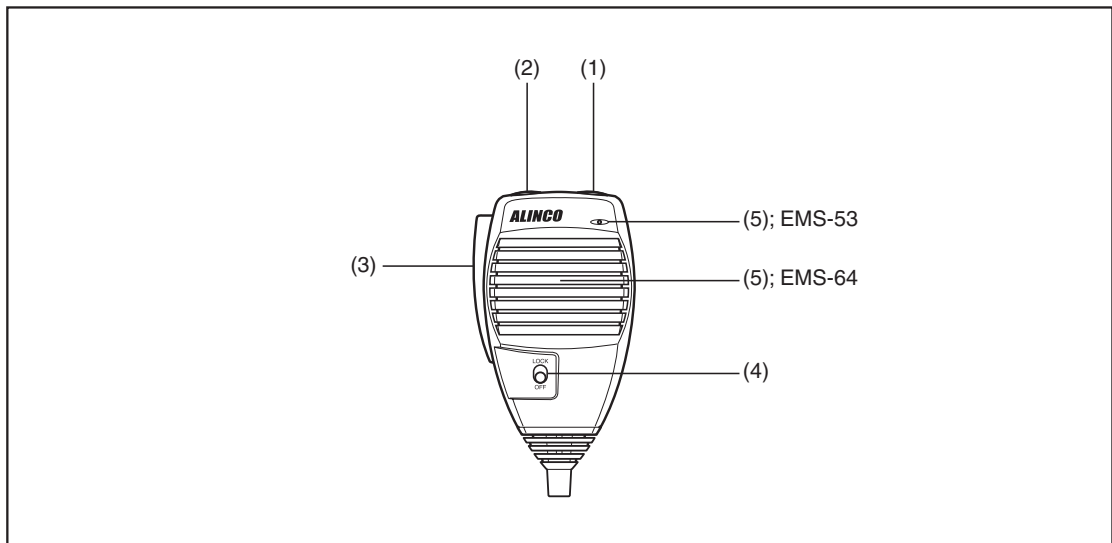

No.	Key	Function
(1)	UP	Increase the frequency, memory channel number, or setting channel.
(2)	DOWN	Decrease the frequency, memory channel number, or setting channel.
(3)	PTT	Press the [PTT (Push-To-Talk)] key to transmit.
(4)	Lock Switch	Locks out the [UP] and [DOWN] keys.
(5)	MIC element	Speak here during transmission.

\* The [UP/DOWN] keys of the microphone function as the [▲/▼] keys of the control panel.



## Display

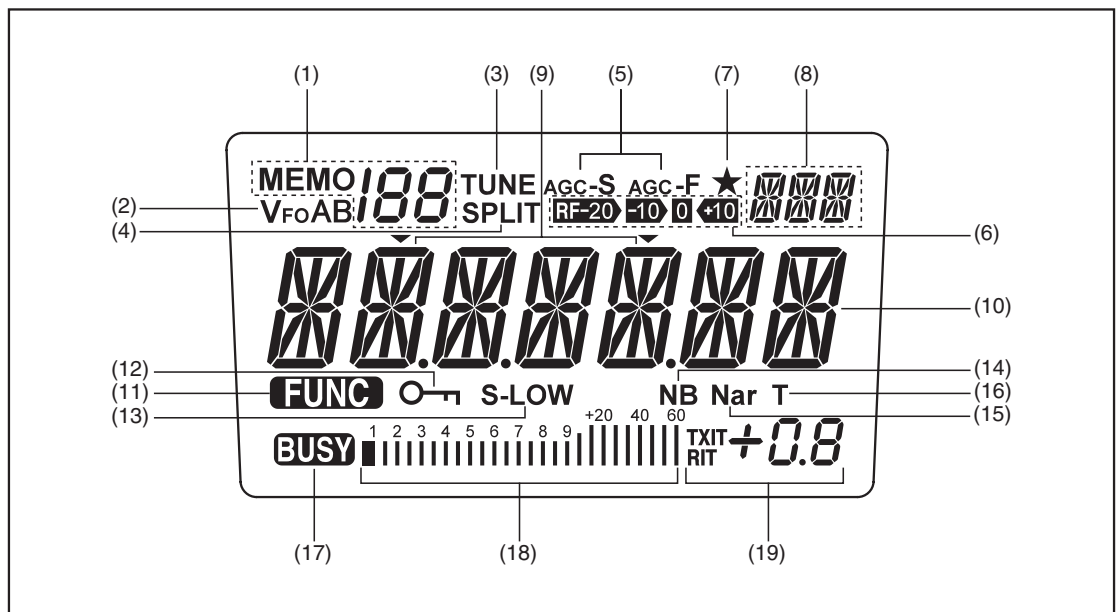

No.	Key	Function
(1)	<b>MEMO188</b>	Appears in the MEMORY mode, indicating the selected memory channel.
(2)	<b>VFOAB</b>	Indicates the selected VFO mode A or B.
(3)	<b>TUNE</b>	Appears while the external automatic antenna tuner is being tuned.
(4)	<b>SPLIT</b>	Appears in the split-frequency operation.
(5)	<b>AGC-S AGC-F</b>	AGC parameter, S for slow, F for fast. (not in FM mode)
(6)	<b>RF-20 -10 0 +10</b>	Indicates the receiver's front-end gain or attenuation level.
(7)	<b>★</b>	Appears when a Multi-function key is activated.
(8)	<b>[Mode icons]</b>	Indicates the selected mode, including LSB, USB, CWL, CWU, FM, AM and SET.
(9)	<b>▼</b>	This cursor notifies of the position you can change using the [M/KHz] key. Appears above the frequency digit you can change with the [UP/DOWN] or [▲/▼] keys.
(10)	<b>[Frequency digits]</b>	Indicates the transmit/receive frequency.
(11)	<b>FUNC</b>	Appears when a function key is activated.
(12)	<b>[Key icon]</b>	Appears when the DIAL or key LOCK function is activated.
(13)	<b>S-LOW</b>	“LOW” appears when the output power is set to low. “S-LOW” appears when the output power is set to supper low.
(14)	<b>NB</b>	Appears when the NB (noise blanker) is activated.
(15)	<b>Nar</b>	Appears when the narrow filter is used in the SSB, CW and AM modes.
(16)	<b>T</b>	Appears during the tone encode operation. (FM mode only)
(17)	<b>BUSY</b>	Appears when squelch is unmuted.
(18)	<b>[S and RF meters]</b>	S meter: Indicates relative received signal strength RF meter: Indicates relative output power level.
(19)	<b>TXIT RIT +0.8</b>	Indicates the TXIT or RIT shift frequency.

## Quick Reference of Control keys

There are 3 types of key operations; simply press it, press it after [FUNC] key, or press and hold it for more than 1 second (\*).

**NOTE:** FUNC + this key: Press [FUNC] key, then press this key.  
(P.xx) refers to the page this operation is mentioned in this manual.

	<b>This key only</b>	<b>FUNC + this key (See NOTE)</b>
FUNC	Accesses the FUNC mode. * Accesses Parameter setting mode. (P.70)	—
V/M	Switches between VFO Mode and Memory Mode. * Activates VFO A = B function (P.66)	Switches to memory bank. * Program memory channels.
M/KHz	Changes cursor position for setting band/ memory/frequency with [UP/DOWN] keys. (P.27)	Switches between AGC-S and AGC-F.
MODE	Selects the USB, LSB, CWU, CWL, AM, FM modes. * The mode UP/DOWN operation is available. (P.26)	Switches between UT and LT. (P.46)
RF	Changes RF gain. * Monitors transmit frequency. (P.45)	Switches between narrow filter ON/OFF. (P.64)
LOCK	Locks main dial tuning. (P.68)	Locks keys and main dial tuning. (P.68)
MULTI	Accesses the Multifunction. (P.67)	The allotment setting of the [MULTI] key.
▲	UP of MHz, kHz, BAND and Memory. * Changes automatically while the key is pressed.	—
▼	DOWN of MHz, kHz, BAND and Memory. * Changes automatically while the key is pressed.	—
RIT	Switches TXIT/RIT function ON/OFF. (P.65)	±Δf function of TXIT/RIT. (P.66)
1	To recall the 1.8 MHz BAND. Frequency direct input “1”.	Switches between VFO A and VFO B. Switches between memories bank A, B and blank.
2	To recall the 3.5 MHz BAND. Frequency direct input “2”.	Transfers memory to VFO. (P.53)
3	To recall the 5.3 MHz BAND. Frequency direct input “3”.	Erases memory channel. (P.52)
4	To recall the 7 MHz BAND. Frequency direct input “4”.	Switches CTCSS tone ON/OFF. (P.42) (FM Mode only)
5	To recall the 10 MHz BAND. Frequency direct input “5”.	SPLIT function ON/OFF. (P.45)
6	To recall the 14 MHz BAND. Frequency direct input “6”.	PRIORITY function ON/OFF. (P.61)
7	To recall the 18 MHz BAND. Frequency direct input “7”.	QUICK OFFSET function. (P.42)
8	To recall the 21 MHz BAND. Frequency direct input “8”.	The scan starts. (P.57)
9	To recall the 24 MHz BAND. Frequency direct input “9”.	NB (noise blanker) ON/OFF. (P.64)
0	To recall the 28 MHz BAND. Frequency direct input “0”.	Changes RF output power. (P.34)
.	Enters a frequency direct input 100 kHz. Frequency direct input decimal	Starts tuning an external automatic antenna tuner. (Option)
ENT	Enters a frequency direct input.	Channel name (Alphanumeric) registration function. (Only in Memory Mode) (P.53)

# Chapter 2 Communications

## 2.1 Reception Basics

### Introduction

Reception is a basic transceiver operation. In this section, you can familiarize yourself with the operation of controls used for reception.

### Procedure

#### 1. Turning the unit power on and off.

**NOTE:** Make sure that all antenna and power connections are correct before turning the power on.

1. By pressing the [PWR] key the power turns on. By pressing the [PWR] key again, the power turns off.



#### 2. Audio Volume level setting.

- Turn the VOL knob clockwise to increase the audio volume.
- Turn the VOL counterclockwise to decrease the audio volume.

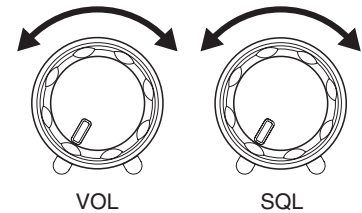

#### 3. Squelch level setting

Adjust threshold level of the squelch. A squelch eliminates the background noise when a signal is not received.

1. Turn the SQL knob clockwise until white-noise (the background noise when a signal is not received) just disappears.
  - The SQL should be turned fully counterclockwise when receiving weak or unstable signals. The RX LED lights green while the squelch is open (unmuted).

### 4. Selecting mode (modulation)

Press the [MODE] key to change the mode as below.



Hold down the [MODE] key more than 1 second to flash the displayed mode. Select a mode by pressing the [▲/▼] keys, or [UP/DOWN] keys on the microphone.



The flashing display stops at the next key operation.

**NOTE:**

- The SSB mode is most frequently used in HF bands. Usually, the LSB mode is used below 10 MHz amateur band, and the USB mode is used above 14 MHz amateur band.
- The AM is commonly used to listen to MW and SW broadcasts.
- The FM mode occupies a wide bandwidth: this will allow reproduction of high quality sound that is less affected by noise. The FM mode is used in 29 MHz.
- The CW mode is used in Morse communications.
- DX-SR8 remembers the last used mode.

### 5. Selecting amateur radio bands

Amateur radio bands are frequency bands that hams are allowed to use. DX-SR8 covers all amateur radio bands ranging from 1.8 MHz to 29 MHz.

1. Press the [M/KHz] key repeatedly until the cursor ▼ flashing appear above the MHz frequency indication.

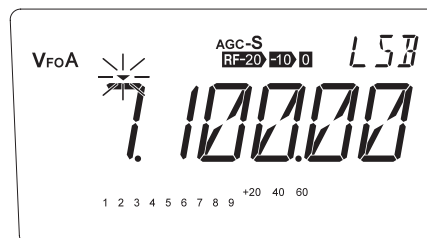

2. Press the [▲/▼] keys or push the [UP/DOWN] key of the microphone to select the desired band.

**NOTE:** When you select a band, the LCD will display the last-used frequency in that band.

**NOTE:** When a band is changed, you might hear the clicking noise of relays but this is not a defect.

- Each time the [M/KHz] key is pressed, ▼ shifts in the following manner:

▼ flashing above MHz frequency indication.

Changes the BAND.

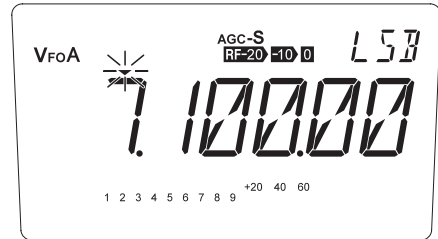

▼ above MHz frequency indication.

Changes the 1 MHz digit.

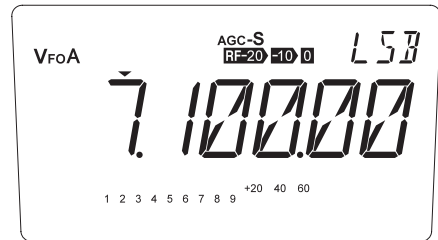

▼ flashing above 1 kHz frequency indication.

Changes the 100 kHz digit.

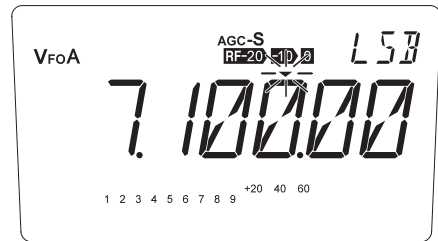

▼ above kHz frequency indication.

Changes by minimum steps.

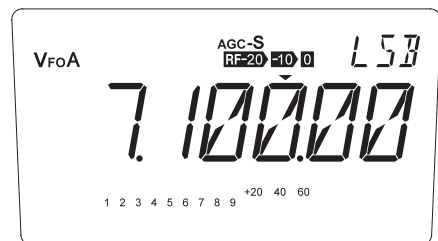

- Default settings (Default band, frequency and mode for both VFO A and B)

Keypad	Band (MHz)	default (Mode)	Keypad	Band (MHz)	default (Mode)
1	1.8	1.900.00 MHz (LSB)	6	14	14.100.0 MHz (USB)
2	3.5	3.600.00 MHz (LSB)	7	18	18.100.0 MHz (USB)
3	5.3	5.330.50 MHz (USB)	8	21	21.100.0 MHz (USB)
4	7	7.100.00 MHz (LSB)	9	24	24.900.0 MHz (USB)
5	10	10.100.0 MHz (USB)	0	28	28.100.0 MHz (USB)

## 6. Tuning to a desired frequency

### Using VFO's

Press the [FUNC] key, then press the [1] key will switch between the VFO A and VFO B. Select either VFO.

NOTE: DX-SR8 has the VFO and MEMORY modes (see page 51). In the VFO mode, different frequencies and settings can be set in each individual VFO A and VFO B.

### Using the main tuning dial

- Turn the main tuning dial clockwise to increase the frequency.
- Turn the main tuning dial counterclockwise to decrease the frequency.

NOTE: In the SSB and CW modes, rotating the dial will change the frequency in 10 Hz steps (One full rotation will change frequency by 500 Hz). In the AM and FM modes, rotating the dial will change the frequency in 100 Hz steps (One full rotation will change frequency by 5 kHz).

### Using the [▲/▼] key ( or using the [UP/DOWN] keys on the microphone)

1. Move the cursor to desired position by pressing the [M/KHz] key.
2. Press the [▲] key to increase the frequency.  
Press the [▼] key to decrease the frequency.

NOTE:

- Frequency step is different by mode. The step can be selected in the set mode (see page 71,72). The default is 0.1 kHz for SSB and CW, 1 kHz for AM, and 2.5 kHz for FM.
- In mobile operation, the selected frequency may be accidentally changed by the vibration, etc. To prevent this, use [🔒] key for lock features. (see page 68)  
In "dial-lock" status, tuning is still possible with the [▲/▼] key and RIT control knob.

## Exercise

- Try receiving a 28.200 MHz signal in the AM mode.

1. Make sure that antenna connection is correct.
2. Turn the power on.
3. Rotate the VOL knob to adjust the audio level.

**NOTE:** Be sure that the SQL knob is fully turned to the left to unmute the squelch.

4. Press the [M/KHz] key repeatedly until ▼ flashing appears above the MHz frequency indication (amateur radio band selection position).

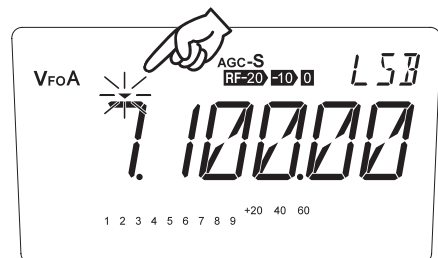

5. Press the [UP/DOWN (or [▲/▼] key)] keys to select the 28 MHz band.

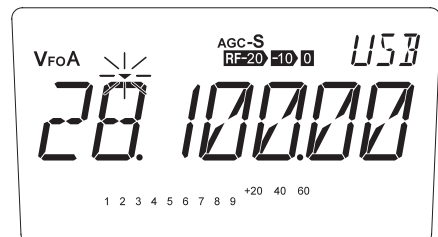

6. Press the [M/KHz] key repeatedly until ▼ flashing appears above the 1 kHz frequency indication.

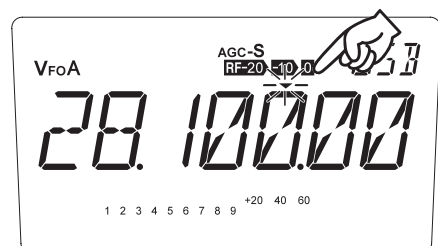

7. Press the [UP/DOWN] key to set the frequency to 28.2 MHz. Press the [M/KHz] key once again to stop flashing the ▼ cursor.

8. Press the [MODE] key to select the AM mode.

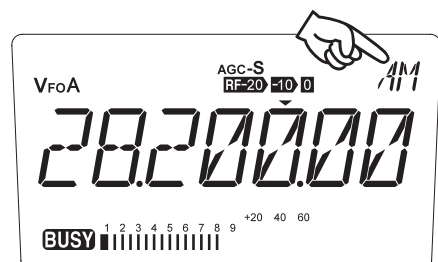

9. Turn the SQL control knob clockwise until the background noise just disappears.
  - To receive the neighbouring frequencies, use the main tuning dial.

- Likewise, try receiving different frequencies in each band.

## Direct Frequency Entry with Keypad

The transceiver has a keypad for direct frequency entry as described below.

1. Press the [ENT] key, then press the numeral keys on the keypad to enter the MHz digits for the desired frequency.  
If a key is mistakenly pressed, press any key except keypad and start again from the beginning.
2. Press the [·] key on the keypad to separate MHz and kHz units.
3. Press the numeral keys to enter the frequency digits below 1 MHz.  
If a key is mistakenly pressed, press any key except keypad and start again from the beginning.
4. Press the [ENT] key to set the input frequency.  
When pressing the [ENT] key after entering the MHz digits, zeros are automatically entered for the kHz digits.  
\* When direct frequency entry with keypad, the mode does not change even if Automatic USB/LSB Selection is effective.

• Start

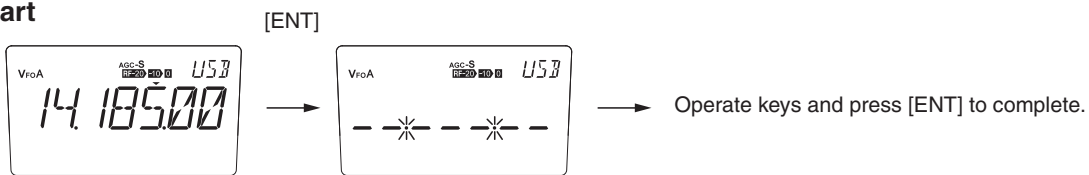

EXAMPLE

• To set to 21.035 MHz

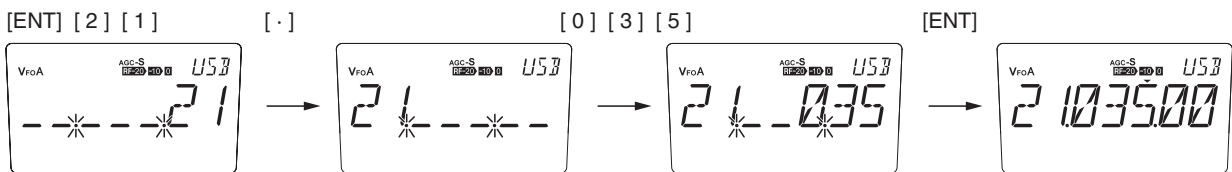

• To set to 705 kHz (0.705 MHz)

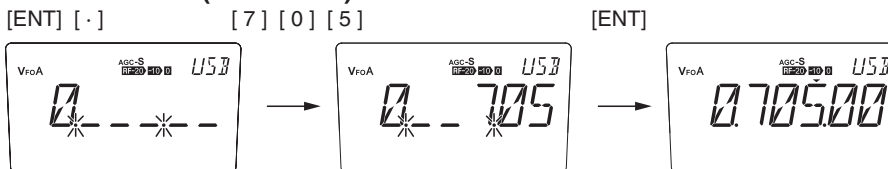

• To set to 7 MHz

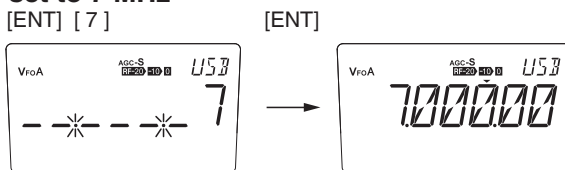

• To change 14.185 to 14.750 MHz

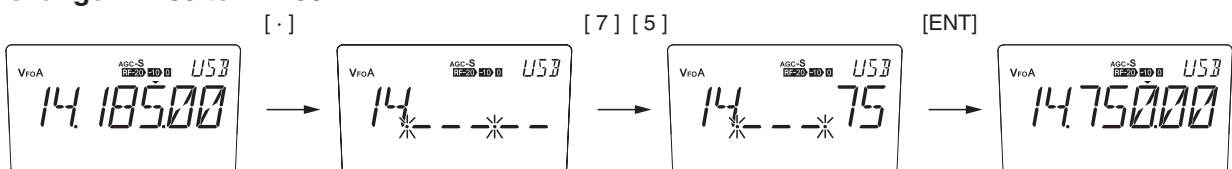







## Getting Familiar with Useful Functions

In HF band, receive conditions vary not only with bands and modes but with time and season. To obtain optimum signal reception, get familiar with and take full advantage of these versatile functions.

### RF (RF gain)/ATT (attenuator)

1. Press the [RF] key to select one of the receiver's front-end gain settings.
  - Each time the [RF] key is pressed, the following icon will appear on the LCD:
    -  A 10 dB preamplifier is activated. This mode will be useful when receiving weak signals.
    -  This is the factory's default setting. Usually select this setting.
    -  A 10 dB attenuator is activated. When receiving strong local signals, select this setting.
    -  A 20 dB attenuator is activated. Select this setting when receiving very strong local signals or when you find such signals near the received signal.

**NOTE:**

- Use of preamplifier may result in intermodulation, heavier noise level, and other side-effects.
- In 10 dB attenuator position, a noise level may become slightly higher than the default position. This is due to the circuit design and not a defect.

### AGC (Automatic Gain Control)

- The AGC function automatically adjusts the gain of strong signals and weak signals so that you can hear them at the same volume.
1. Press the [FUNC] key, then press the [M/KHz] key to select either the AGC-S or AGC-F mode.

**NOTE:** You may select either AUTO or MANUAL for the [FUNC] key operation. In Auto setting, FUNC status is automatically canceled if no key entry is performed within 5 seconds after the [FUNC] is displayed. Refer to the Menu 23 in the Set mode (page 83) for more details.

- AGC-S mode: The AGC recovery time is long, and suitable to SSB and AM modes.
- AGC-F mode: The AGC recovery time is short, and suitable to CW mode.

**NOTE:** The AGC is automatically set to Fast in CW, Slow in SSB and AM modes. You can manually change from S to F or vice versa during operation but turning off the unit will reset the temporary setting. If you prefer to manually select the AGC setting always and wish that the setting remains regardless of power on/off, please select the OFF parameter in the Set mode menu 10 (P.77).

### RIT (Receiver Incremental Tuning)

1. Press the [RIT] key. The “RIT” icon will appear on the LCD.

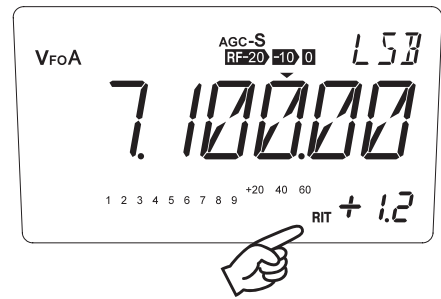

2. Rotate the RIT control knob to adjust the frequency.
  - \* To exit from the RIT function, press the [RIT] key repeatedly until both “RIT/TXIT” icons disappear.
  - \* Press the [FUNC] key, then press the [RIT] key to add the RIT shift frequency to the operating frequency and exit from RIT operation. Please refer to page 65 RIT/TXIT function for more details.

---

---

## 2.2 Transmission Basics

### Introduction

This section explains the preparations and basic procedures for transmission.

### Procedure

#### Transmitting in the voice mode (SSB, AM and FM)

1. Make sure that all antenna, power, and microphone connections are correct.
2. Turn the power on.
3. Using the normal reception procedure, select a clear frequency free of other stations or select the frequency of a station to communicate with.
4. Set the output power level if necessary (see page 34).
5. Press and hold the [PTT] key and speak into the microphone.  
The red TX LED will be lit.

**NOTE:** Speaking too loud or too close to the microphone may increase distortion.

**REFERENCE:** Adjusting the microphone gain, page 85.

6. Release the [PTT] key to stop transmitting and return to receive.

#### Transmitting in the CW mode

Keying will automatically start transmit.

1. Make sure that all antenna, power, and microphone connections are correct.
2. Turn the power on and set for reception.
3. Set the output power level if necessary (see page 34).
4. Set the desired BREAK-IN mode (see page 79).

**NOTE:** The default setting is the AUTO BREAK-IN mode, meaning the delay time for the SEMI BREAK-IN mode will be set automatically according to transmitting CW speed.

5. Begin keying.  
The red TX LED will be lit.
6. Stop keying.  
Transmission will stop automatically.

### Selecting output power level

To select the output power, press [FUNC] key and then press [0] key while “FUNC” icon is on the display. As the [0] key is pressed, the output power changes among 3 levels. The “S-LOW” icon stands for SUPPER LOW power setting, “LOW” for LOW power. When the transceiver is set at HIGH power, no icon will appear. The output power level cannot be changed during transmission.

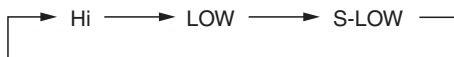

SSB, CW, FM	Hi	100 W
	LOW	10 W
	S-LOW	1 W
AM	Hi	40 W
	LOW	4 W
	S-LOW	0.4 W

**NOTE:** The fan starts to run at 60 °C (140°F/inside temperature), and reduces the power by about 50% at 80 °C (176°F). It stops or resumes high power when the inside temperature is cooled down.

Speech compressor: increases talk power to enable clear and powerful transmission. See the Set mode Menu 19 (P.81) for more details.

- TXIT (Transmit Incremental Tuning) function (See page 65)
  - \* Press the [RIT] key repeatedly until the “TXIT” icon appears. Then rotate the RIT control knob to change the transmit frequency within a range  $\pm 1.2$  kHz.
  - \* When the “TXIT/RIT” icon appears, it means that you can fine-adjust both transmit and receive frequencies.

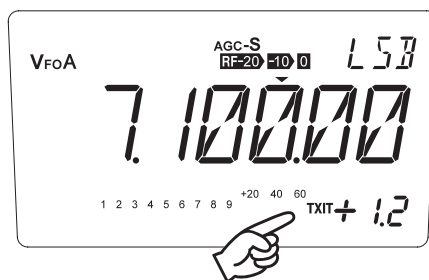

- OFF BAND display:  
Stop transmission when you attempt to transmit outside of the amateur radio band. The LCD will display the following:

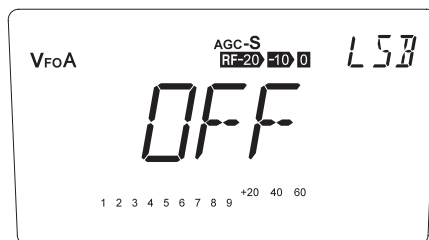

## 2.3 SSB Operation

### Introduction

The SSB (Single Side Band) mode is most frequently used for voice communication in HF bands.

### Procedure

**NOTE:** Make sure that all antenna, power, and microphone connections are correct.

1. Turn the power on.
2. Select the desired amateur radio band (see page 27).
3. There are two types of SSB mode: USB (Upper-Side-Band) and LSB (Lower-Side-Band).  
The LSB or USB mode will be automatically selected according to the selected band.

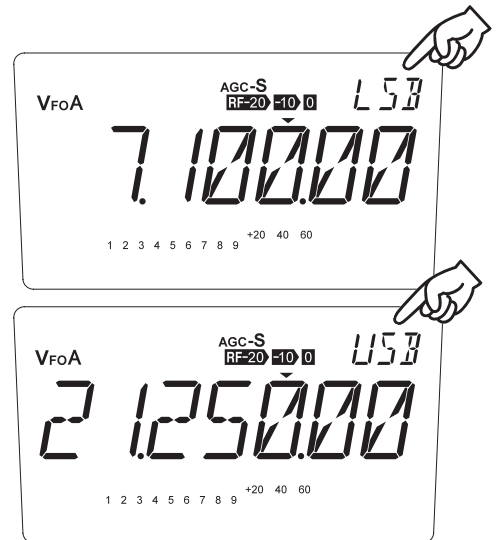

**NOTE:**

- If the Automatic USB/LSB Selection function is set to off, the last-used SSB mode is recalled.
- The transceiver's squelch circuit interacts with the S meter. Therefore, if the AGC-F mode is selected in the SSB mode, squelch may be muted and unmuted according to the signal strength. To prevent this, it is recommended to select the AGC-S mode rather than the AGC-F mode.

4. Tune in a station to communicate with.
  - Fine-tune to a frequency at which the signal from the station is clearly heard.

**NOTE:**

- Be sure to set the RIT knob back to the original position before contact is made. Otherwise, your frequency will shift off the other station's frequency.
- Check to see the frequency is not used by other stations before transmitting.

5. Press and hold the [PTT] key and speak into the microphone.  
The red TX LED will be lit. The reading on the RF meter and brightness of the TX LED will change according to the intensity of your voice.

**NOTE:** Speaking too close to the microphone or too loudly may increase distortion and reduce clarity.

6. Release the [PTT] key to receive.

**REFERENCE:** Split-frequency operation, page 45.

## 2.4 Practical Techniques for SSB Operation

### Introduction

In SSB operation, you may encounter various problems such as poor propagations and interferences. This section explains how to use the special functions to overcome these problems.

### Eliminating Interference (QRM)

#### 1: Activating the IF SHIFT function

This function eliminates interference by shifting the filter pass band without changing the receive frequency.

Turn the  $\Delta$ IF knob clockwise or counterclockwise to lessen interference.

#### 2: Using the filter

Press the [FUNC] key, then press the [RF] key. “Nar” appears on the display indicating that the narrow filter is selected.

#### 3: Activating the RF attenuator

When the received signal is noisy, it is possible that you are picking up another strong signal from nearby.

Press the [RF] key to activate the attenuator to a desired level.

## Communicating in Bad Conditions

In HF band, propagations depend on time, season, and propagation paths. For example, signals from the other station may fade or alternate between strong and weak. In this case, perform the following.

### 1: Using the RF preamplifier

Press the [RF] key repeatedly until [+10] appears.

### 2: Selecting the AGC-F mode

In the SSB mode, the AGC-S mode is usually selected. However, if there are strong signals or noise near a weak signal, the signal is suppressed by the strong signals or noise. In this case, select the AGC-F mode to improve receiving conditions.

Press the [FUNC] key, then press the [MHz] key the "AGC-F" appears on the display.

## Communicating with Off-frequency Stations

When communicating with a station that drifts his transmitting signal (QRH), use RIT so that you can fine-tune to his transmitting frequency without shifting your transmission signal.

### Activating the RIT function

Press the [RIT] key and rotate the RIT control knob to fine-tune to the receiving frequency.

- The RIT operation does not change your transmit frequency so that the other station does not need to shift the receive/transmit frequency.

## Communicating in Pile-ups

Speech compressor increases the average power of the transmitted signal by amplifying the weak part of your speech. It helps communicating in poorer propagation conditions or in pile-ups.

**NOTE:** Pile-up - the condition where many stations call one station at the same time.

### Using the speech compressor

Set the speech compressor to "ON" in the Set mode (see page 81).

**NOTE:** Speech-compressed signal may sound distorted or unnatural in better communication conditions.

## 2.5 AM Operation

### Procedure

NOTE: Make sure that all antenna, power, and microphone connections are correct.

1. Turn the power on.
2. Select the desired operating band (see page 27).
3. Press the [MODE] key to select the AM mode.

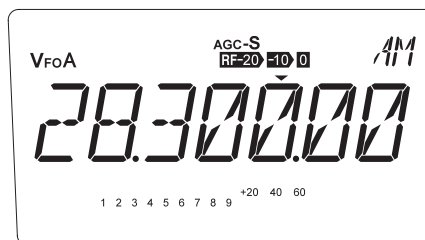

4. Tune in a station to communicate with.

NOTE: Check to see the frequency is not used by other stations before transmitting.

5. Press and hold the [PTT] key and speak into the microphone.  
The red TX LED will be lit. The reading of the RF meter will change according to the intensity of your voice.

NOTE: Speaking too close to the microphone or too loudly may increase distortion and reduce clarity.

6. Release the [PTT] key to return to receive.

NOTE:

- The output power level in the AM mode is lower than in the other modes (see page 34).
- Using the speech compressor will increase the readability of your transmit signal in poor communicating conditions. (see page 81).
- Using the narrow filter in conjunction with the IF SHIFT function will effectively reduce interference (see page 62).



## 2.6 General Coverage Receiver Operation

### Introduction

This section explains procedures for receiving MW and SW broadcasts using the general coverage receiver function.

### Procedure

Example: Receiving a 670 kHz (0.670 MHz) MW broadcasts

1. Make sure that all antenna and power connections are correct.
2. Turn the power on. Adjust audio level.
3. Press the [M/KHz] key repeatedly until ▼ flashing above the 1 kHz frequency indication.
4. Press the [▲] key until 7 appears on 100 kHz digit indication.
5. Press the [M/KHz] key once to stop flashing ▼.
6. Press and hold [▼] key to select 70 for 10 kHz and 1 kHz order. After 3 second the step turns faster. Now the display shows 7.670.00.
7. Press the [M/KHz] repeatedly until ▼ appears above the 1 MHz frequency indication.

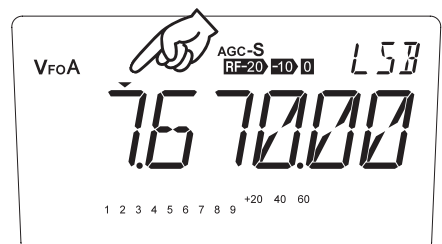
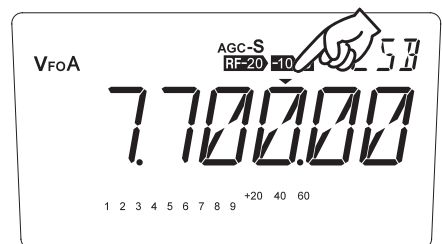
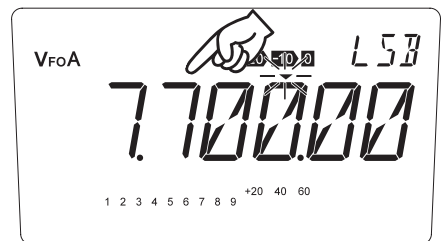
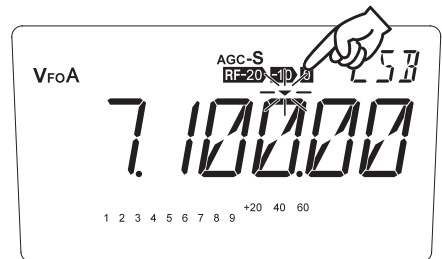

8. Press the [▼] key until 0 appears on 1MHz digit indication.
9. Press the [MODE] key to select the AM mode.

**NOTE:** You may operate [M/KHz] key to select MHz digit as you like first, but depending on the frequency combination in relation to the band-plan programming, zero on the MHz order may not be shown. In such case as above, you may tune the 100 kHz order first then tune to the 1 MHz order to avoid this.

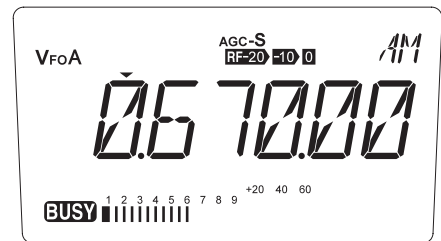

**REFERENCE:** It is much easier to use the numeric keys to enter the frequency direct. See Page 30 for details.

## 2.7 FM Operation

### Introduction

In the FM (Frequency Modulation) mode, you can enjoy high quality sound that is less affected by noise. This mode is frequently used in the 29 MHz band as well as VHF and UHF bands.

### Procedure

**NOTE:** Make sure that all antenna, power, and microphone connections are correct. Be sure to the FM mode allocation of the band-plan in your area.

**1.** Turn the power on.

**2.** Adjust squelch level.

**NOTE:** If squelch level (threshold) is set too high, the transceiver will not be able to pick up weak signals.

**3.** Select the desired operating band (see page 27).

**NOTE:** In the FM mode, DX-SR8 is designed to use the super narrow ( $\pm 2.5$  kHz deviation).

**4.** Press the [MODE] key to select the FM mode.

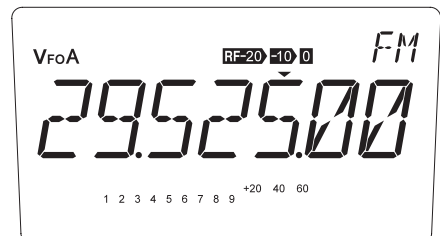

**5.** Select the desired frequency.

**NOTE:**

- Check to see the frequency is not used by other stations before transmitting.
- When tuning, the [ $\blacktriangle$ / $\blacktriangledown$ ] keys may be more useful than the main tuning dial. Frequency step for the [ $\blacktriangle$ / $\blacktriangledown$ ] keys can be selected in the Set mode (see page 72).

**6.** Press and hold the [PTT] key and speak into the microphone.  
The red TX LED will be lit.

**7.** Release the [PTT] key to return to receive.

## 2.8 Repeater Operation (QUICK OFFSET)

### Introduction

This section explains procedures of how to access to a repeater. The function explained in this section is referred to as a “QUICK OFFSET”.

### Procedure

Example: Selecting 29.640 MHz for reception and 29.540 MHz for transmission

1. Make sure that all antenna, power, and microphone connections are correct.
2. Turn the power on.
3. Adjust squelch level.
4. Set 29.640 MHz in the VFO A.
5. Press the [MODE] key to select the FM mode.
6. Press the [FUNC] key, then press the [4] key if CTCSS tone encode is required. [T] will appear at the lower left.
7. Select the proper CTCSS tone frequency. (See page 81)
8. Press the [FUNC] key, then press [5] key. The "SPLIT" will appear on the LCD.
9. Press the [FUNC] key, then press [7] key. Press and hold the [▼] key or the main tuning dial to select "-0.100.00". And then press any key other than the [M/KHz] key and the [▲/▼] keys.
10. Press and hold the [PTT] key and speak into the microphone.
11. Release the [PTT] key to return to receive.

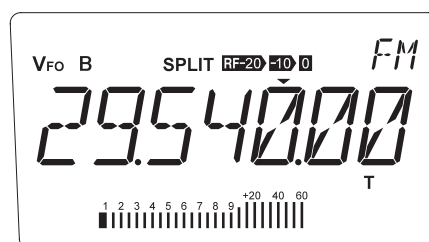
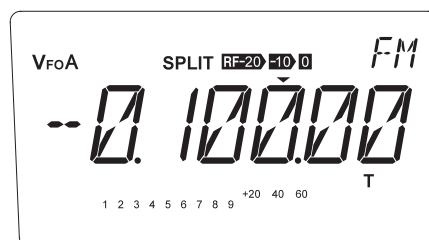
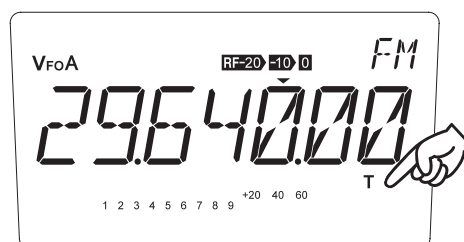

**NOTE:** It is useful to store repeater frequencies in memory channels. Each memory channel can store a split frequency setting (see page 49).

## 2.9 CW Operation

### Introduction

In the CW (Continuous Wave) mode, you communicate with other stations by transmitting and receiving Morse code. The code is keyed with a telegraph key.

### Procedure

**NOTE:** Make sure that all antenna, power, and key connections are correct.

1. Turn the power on.
2. Select the desired operating band (see page 27).
3. Press the [MODE] key to select either the CWL or CWU mode.
  - The CWL mode switches reception from the upper sideband to the lower sideband; this is similar to the LSB mode, but suited to CW reception.
  - The CWU mode switches reception from the lower sideband to the upper sideband; this is similar to the USB mode, but suited to CW reception.
4. Select a frequency of a station to communicate with.
  - Pressing and holding the [RF] key allows you to monitor your transmit frequency by sidetone.

While pressing the [RF] key longer than 1 second, press the telegraph key down and rotate the main tuning dial until the received signal and the sidetone are heard at the same pitch (zero-in operation).

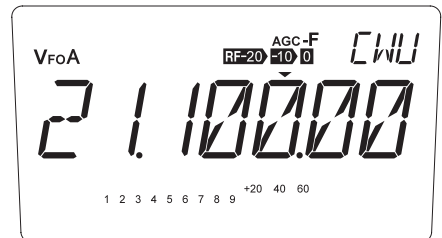

**NOTE:**

- The sidetone can be selected from 400-1000 Hz step in the Set mode.
- When tuning in a CW signal, be sure to tune in the correct side beat. You can hear the same signal on the opposite side beat which is separated at twice the side tone frequency. The correct beat is stronger, and is always on upper side when receiving in CWL and lower side when receiving in CWU.
- In CW mode, we suggest that the squelch knob set to fully counterclockwise until you get familiar with the operation.

5. Start keying.

**NOTE:** DX-SR8 has the FULL BREAK-IN and SEMI BREAK-IN modes. For the SEMI BREAK-IN mode, you can select one of eight levels including the AUTO mode, in which the delay time is set automatically.

6. Stop keying to receive.  
Adjusting the sidetone frequency, page 85.

## 2.10 Practical Techniques for CW Operation

### Introduction

In CW operation, you will encounter various problems such as poor propagations and interferences. This section explains how to use the special functions to overcome these problems.

### Reducing Interference

#### 1: Activating IF SHIFT function

This function eliminates interference by shifting the filter pass band without changing the receive frequency.

Turn the  $\Delta$ IF control knob clockwise or counterclockwise to reduce interference.

#### 2: Using the filter

Using the narrow filter in conjunction with the IF SHIFT function will more effectively eliminate interference.

To use the CW filter, press the [FUNC] key then press [RF] key. Repeat to disengage.

#### 3: Activating BFO REVERSE function

Select the CWU or CWL mode.

- If your station and the other station are zeroed-in, this function will not change the receive tone and transmit frequency. See page 64 for more details.

#### 4: Activating the RF attenuator

The attenuator can protect the received signal from suppression and cross-modulation caused by neighboring signals.

### Communicating in Bad Conditions

#### Activating the RF preamplifier

Press the [RF] key repeatedly until [+10] appears.

The preamplifier will come on.

#### Activating the RIT function

Press the [RIT] key and rotate the RIT control knob to clarify the signal.

### Communicating in Pile-ups

#### Selecting the FULL BREAK-IN mode

In this mode, keying will transmit and un-keying will receive automatically. This allows you to call with perfect timing.

Select the FULL break-in mode in the Set mode (see page 79).

## 2.11 Split-Frequency Operation

### Introduction

When communicating with a DX (long distance) station that is using a different operating band or is involved in a pile-up, they may be using one VFO for the receive frequency, and the other VFO for the transmit frequency. This is called “SPLIT” operation. To facilitate this operation, you can activate the QUICK OFFSET function (page 42) as well as the function that allows you receive and to check the transmit frequency.

**REFERENCE: SPLIT and QUICK OFFSET are used in similar purposes.**

**Both differentiate the TX and RX frequency. Use either one to suit your operational comfort.**

### Procedure

Example: Setting the receive frequency to 7.270 MHz and the transmit frequency to 7.070 MHz (This is example only: 7.070 MHz (or 7.270 MHz) may not be allowed for SSB operation in some countries.)

1. Press the [FUNC] key, then press the [1] key to select the VFO B.
2. Set the desired transmit frequency in the VFO B.
3. Press the [FUNC] key, then press the [1] key to select the VFO A. Then set the receive frequency in the VFO A.
4. Press the [FUNC] key, then press the [5] key. “SPLIT” appears on the display.
5. Begin communication as usual.

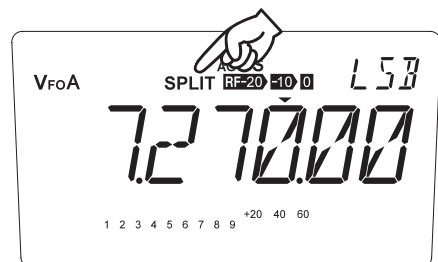
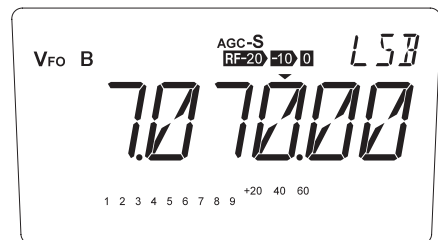

The last displayed VFO (whether A or B) before pressing the [FUNC] key, and the [5] key becomes the receiving frequency.

- To cancel the split-frequency operation, press the [FUNC] key, then press the [5] key again.

**NOTE:**

- Pressing and holding the [RF] key allows you to monitor the transmit frequency during reception. While monitoring, you can fine-tune the transmit frequency using the main tuning dial. Press any key to exit.
- Press the [FUNC] key, then press the [2] key will transfer memory data from the selected VFO A or B to the other VFO B or A. This is useful when setting a split frequency.
- Using the QUICK OFFSET (P.42) function will make it easier in Pile-up split, when the station requires you to shift the current frequency upwards by 20 kHz or downwards by 30 kHz etc.

## 2.12 RTTY Packet Operation (FAX/SSTV)

### Introduction

DX-SR8 has no dedicated features for RTTY packet, FAX, and SSTV operations. However, these operations can be enabled by using the following procedures.

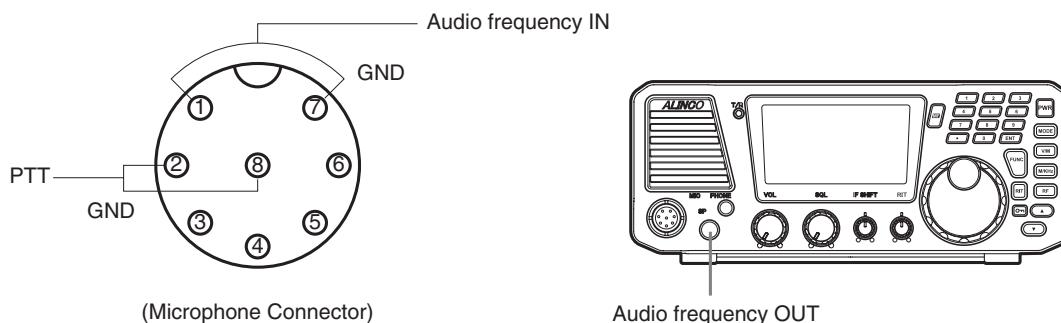

### Connecting Additional Equipment

Pin (1) — To audio output of additional equipment.

Pin (7) — To ground of the audio output.

Pin (2) — To PTT output of additional equipment.

Pin (8) — To PTT GND of additional equipment.

External speaker jack — To RECEIVE SIGNAL. AF-IN.

### Procedure

1. Turn the power on.
2. Select the mode.
  - You may like to choose the mode UT (or LT) which gives a higher pitch passband, suited for data communications such as FAX, SSTV, RTTY, etc. To select UT or LT, press [FUNC] key and then [MODE] key in USB mode for UT, in LSB mode for LT. Press [FUNC] key and then [MODE] key again to go back to USB/LSB modes.
  - The change of UT/LT is automatic when AUTO is selected in Menu 9 (Page 77), it turns to UT for USB bands, LT for LSB bands.
3. Select the desired operating band.
4. Start receiving.

	Mode commonly used	DX-SR8
RTTY (AFSK)	LSB	LT
AFSK (300 baud)	SSB	UT/LT
AFSK (1200 baud)	FM	FM
FAX	SSB/FM	UT/LT/FM
SSTV	SSB/FM	UT/LT/FM

**REFERENCE:** Third-party-mode peripherals are available to ease data-mode operations. Please follow instructions of the devices as well in case you use them.



# Chapter 3 Memory Features

---

## 3.1 Basics

This transceiver has three memory banks. 200 memory channels are available in each bank, for a total of 600 channels. Each can retain different operating data such as receive and transmit frequencies mode, tone etc. It is useful to store regularly used frequencies in the memory and operate in the memory mode.

### Features

Each Memory channel including 00-199 and P1, P2 channel can store following parameters:

- Transmit/receive frequency (including split frequency)
- Mode (SSB, CW, FM, AM, etc.)
- Filter (standard/narrow, not applicable in the FM mode)
- RF (preamplifier/attenuator, not applicable in the FM mode)
- AGC (slow/fast, not applicable in the FM mode)
- NB (ON/OFF, not applicable in the FM mode)
- Tone (ON/OFF, for FM mode only)
- SPLIT (ON/OFF)
- Output power
- Skip channel setting

### Functions in the MEMORY mode

- Memory frequency access protection (see page 73)
- Memory overwrite protection (see page 72)
- Memory-VFO transfer (see page 53)

## 3.2 Simplex-VFO-Frequency Programming

### Procedure

Example: Storing 7.050.00 MHz and LSB into memory channel “188” in bank A.  
Please note that a symbol □ stands for “blank” bank and nothing appears on the display.

#### Setting data

1. Set the data to be stored in VFO mode.

#### Selecting a memory channel

2. Press the [FUNC] key. The memory number starts to flash.
3. Pressing [V/M] key switches the bank □ (blank), A and B, select the A bank.

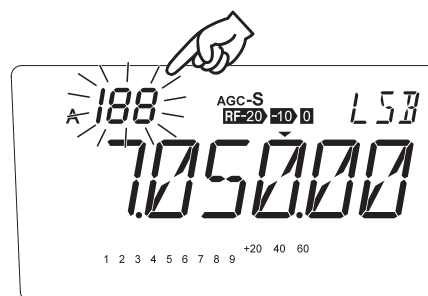

4. Press the [▲/▼] keys (or the [UP/DOWN] keys of the microphone) to select memory channel “188”. In this case, [▼] or [DOWN] key works faster to select “188”.

An empty channel is shown with a flashing [Memory No.].

5. Press and hold the [V/M] key for more than 1 second while “FUNC” is on the display, a beep sounds, then flashing number disappears to complete the memory programming.

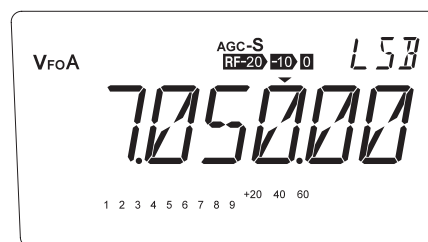

6. If a previously programmed channel is selected in step 4, the memory channel will be overwritten by executing the procedure in step 5.

Read P.51 for memory operation

**NOTE:** To avoid overwriting, use overwrite protection in the Set mode menu 01, P.72.

## 3.3 Split-Frequency Programming Using Quick Offset Function

### Procedure

Example: Programming 14.275.00 MHz (transmit frequency) and 14.250.0 MHz (receive frequency) into memory channel “59”

#### Setting data

1. Set 14.250 MHz (receive frequency) in either VFO A or VFO B.

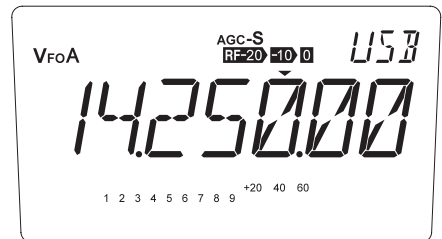

2. Press the [FUNC] key, then press [5] key. The "SPLIT" will appear on the LCD.

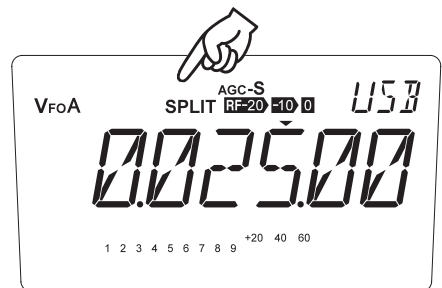

3. Press the [FUNC] key, then press [7] key. Press the [▲/▼] keys or the main tuning dial to select "+0.025.00". And then press any key other than the [M/KHz] key and the [▲/▼] keys. A beep sounds.

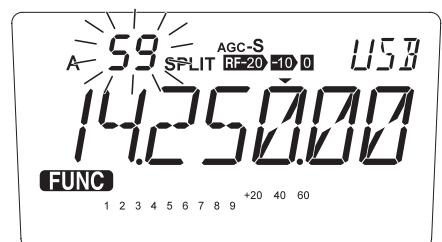

4. Press [FUNC] key, then press the [▲/▼] keys to select memory channel “59”.

5. Press and hold the [V/M] key for more than 1 second. A beep sounds and programming is completed. Read P.51 for memory operation.

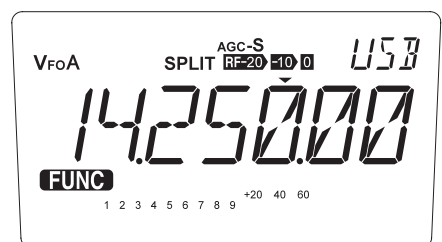

## 3.4 Split-frequency Programming

### Procedure

Example: Programming 29.540.00 MHz (transmit frequency) and 29.640.00 MHz (receive frequency) into memory channel “03”

#### Setting data

1. Set 29.540.00 MHz (transmit frequency) in the VFO A.
  - Select FM mode by [MODE] key. Press [FUNC] then [4] key to activate CTCSS tone encoding. [T] appears on the display.

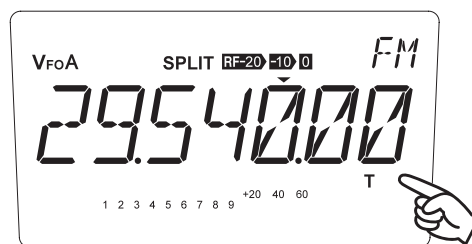

2. Hold the [V/M] key for 1 second until a beep is heard. Press [FUNC] then [1] key to switch to the VFO B. Observe that the VFO B is set to the same state as VFO A.
3. Set 29.640.00 MHz (receive frequency) in the VFO B.

4. Press the [FUNC] then [5] key to indicate “SPLIT” on the display.

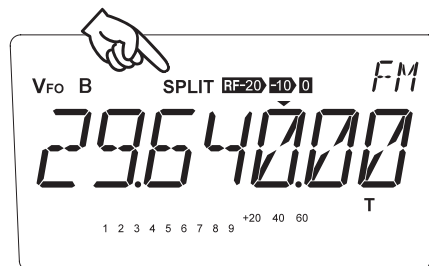

#### Selecting a Memory Channel

5. Press the [FUNC] key while the receive frequency is displayed. The frequency shown in step 2 is the receive frequency.
6. Press the [▲/▼] keys to select memory channel “03.”

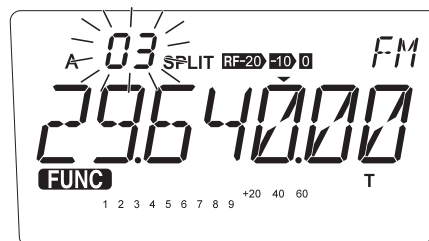

7. Press and hold the [V/M] key for more than 1 second. A beep sounds and completes the setting.

NOTE: There is no priority between A and B. Select either VFO for RX frequency and perform step 7.

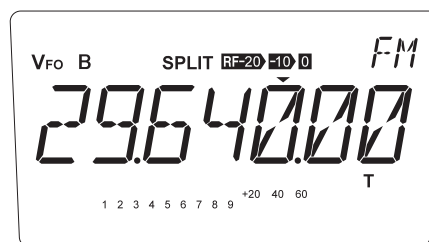

Read P.51 for memory operation.

## 3.5 Memory Mode Operation

### Procedure

#### Accessing the Memory Mode

1. Press the [V/M] key to display the channel number and MEMO.  
The last-used memory channel will be recalled.

NOTE: Memory channel will not appear if nothing has been programmed in the memory.

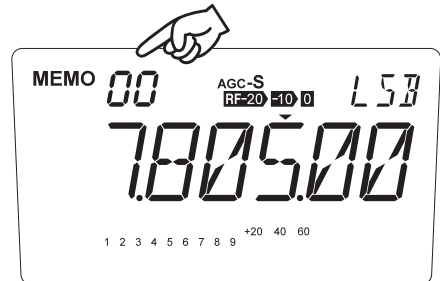

2. To select the bank, press [FUNC] then [1] key. Repeating this will switch between [Blank] → [A] → [B].

NOTE: Empty banks won't appear during this operation. Program at least 1 memory channel in each bank before performing this procedure.

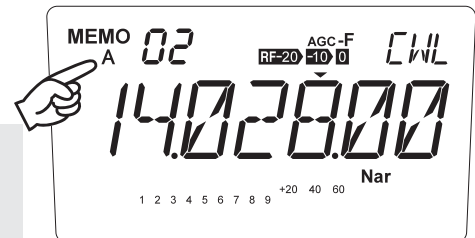

3. Press the [▲/▼] keys to select the desired memory channel.

NOTE:

- Empty channels will be skipped.
- In the Set mode, you can select either permitting the temporary change of parameters like mode, RIT etc. in memory or not. (page 73)

## 3.6 Memory Channel Data Erasing

### Erasing Data in a Selected Memory Channel

1. Press the [V/M] key to access the Memory mode.
2. Press the [▲/▼] keys or press [UP/DOWN] key of microphone to select a memory channel that you want to erase.

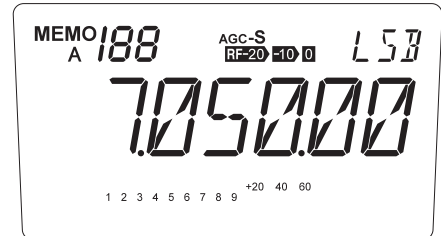

3. Press the [FUNC] key, then press the [3] key.  
The selected channel number flashes and completes the erase.

**NOTE:** Releasing the key will not affect the current LCD indication, but will erase the data in the selected memory channel.

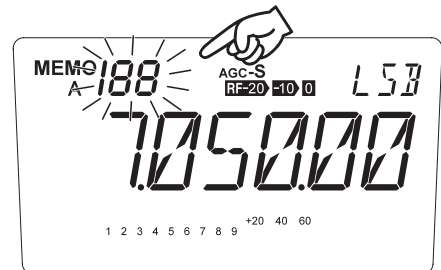

### Erasing All Memory Channels (Memory reset)

1. Turn off the power.  
Turn on with [M/KHz] and [RF] keys pressed together to reset memory data only.

**REFERENCE:** See more details of available reset functions on page 87.

## 3.7 Memory To VFO Data Transfer

### Introduction

This function copies data from any memory channel to the VFO. This is useful when you wish to tune in a station near the frequency stored in a memory channel.

### Procedure

Example: Copying data in memory channel “06” into the VFO A

1. Press the [▲/▼] keys to select memory channel “06” in the memory mode.
2. Press the [FUNC] key, then press the [2] key. While [VFO] icon is flashing, use [▲/▼] keys to select VFO A or B to copy the data, then press [2] key to complete.

**NOTE:** After transfer, the original data still remains in the memory channel.

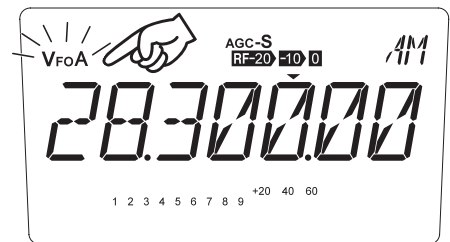

## 3.8 Channel Name (Alphanumeric) Registration Function

The memory channels stored in the memory mode can be displayed with an alphanumeric tag instead of the default frequency display. There are 67 characters available including A-Z, 0-9.

1. In the memory mode, select a channel to be programmed.
2. Press the [FUNC] key, then press the [ENT] key.
3. The display shows [A] flashing.

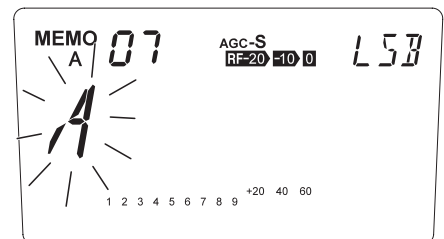

4. Turn the Main dial or press the [▲/▼] keys to select a character to be programmed.
5. By pressing the [ENT] key, the character stops flashing and is entered. An identical character to the one just entered flashes on the immediate right ready to be edited.

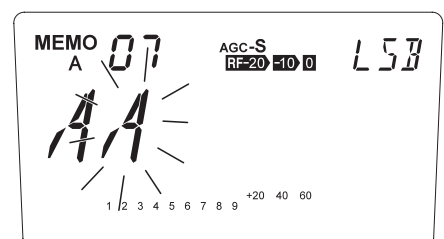

6. Enter the next character with the [ENT] key.  
(Repeat the same sequence)  
In order to store 6 letters for example, repeat the sequence until all 6 letters are entered by [ENT] key, and only 7th digit is flashing. To enter 7 letters, repeat until 1st digit flashes.
  
7. Pressing the [0] key during programming will delete all characters to be programmed. Pressing the [·] key to delete the last character.
  
8. Pressing any key other than the [ENT] key, [0] key, [·] key and [▲/▼] keys will complete the setting and the display will return to the original status.

**NOTE:** In the memory mode, a designated alphanumeric tag is displayed instead of the frequency. Press [FUNC] key to display the frequency temporary. Pressing [FUNC] key again or changing the memory channel will recall the alphanumeric display. In case [FUNC] key parameter is set to AUTO, it returns to the alphanumeric display automatically after 5 seconds.

By pressing any key during operation, the display will return to show the channel name. But by operating a key designated for some [FUNC] key, the unit will enter the designated setting mode.

While displaying the name-tag (alphanumeric display), when you perform frequency-related operation such as changing the frequency using the main dial, the display turns to numeric indication temporary for 5 seconds then goes back to the name-tag.

The following table lists available characters.

A	A	H	H	O	O	V	V	0	0	7	7
B	B	I	I	P	P	W	W	1	1	8	8
C	C	J	J	Q	Q	X	X	2	2	9	9
D	D	K	K	R	R	Y	Y	3	3		
E	E	L	L	S	S	Z	Z	4	4		
F	F	M	M	T	T			5	5		
G	G	N	N	U	U			6	6		



# Chapter 4 Scanning

## 4.1 Basics

### Introduction

Scanning lets you automatically search for signals across a specific frequency range or among programmed memory channels. There are five types of scans; band, programmed, search, memory, and priority.

Basically the squelch must be closed (muted) to run the scans. However, the following scan modes work regardless of the squelch level.

- \* Search Scan
- \* Priority Scan
- \* Timer scan setting parameters are set to one of B1S to B30M. In this case, the scan resumes by elapsed time, not by the presence of the signal (squelch status). This setting may be useful for monitoring data-communication signals that squelch must be opened always, such as Pactor and HF DL aircraft digital geo-locating traffics, in the memory mode

### Scan Types

#### Band scan

This scan searches the entire frequency range of the amateur radio band in user-specified steps.

Band (MHz)	Step
1.8	Frequency steps are set according to mode. Default settings are as follows: SSB, CW: 0.1 kHz AM: 1.0 kHz FM: 2.5 kHz (See page 71, 72 to frequency steps.)
3.5	
5.3	
7	
10	
14	
18	
21	
24	
28	

- When the general coverage receiver is activated, this scan also searches for signals between the amateur radio bands. For example, if the starting frequency is 12.00000 MHz, it scans between 10.1500 MHz-13.9999 MHz in case of T-version.

The following diagram shows how signals are scanned, depending on the frequency where the scan is started.

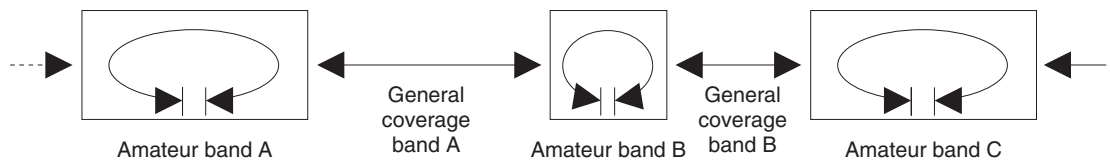

### Programmed Scan

This function scans an user-specified range of frequencies. Before using this function, you need to specify the upper and lower frequency limits for programmed-scanning. These frequencies are called “Programmed scan channels”, and are available a pair in VFO A and VFO B separately. By referring to Page 60, set the upper and lower limit frequencies in the P1 and P2 channels of the memory-bank A for VFO-A, the bank B for VFO-B operations. The P1/P2 channels are not available in the Blank memory bank. The “P” on the display flashes during the Programmed Scan.



**NOTE:**

- The tuning step and modulation mode of the Program scan function are the same as those set for the VFO at moment of scanning.
- The modulation mode stored in P1/P2 memories are always disregarded for programmed scan but P1/P2 channels can be used also as normal "memory channels" for memory operation.

### Search Scans

This search mode is convenient to high-speed scan pre-determined width of frequency regardless of the band of operation.

Suppose the selected range is 100 kHz in the Set mode, and current frequency is 7.102.83 MHz. By activating this function, it scans between 7.100.00 and 7.199.99 MHz shown as the range B below. Press [UP] key during the scan to move up to the next 100 kHz range that is C, or [DOWN] key to scan the range A. Setting 200 kHz in the Set mode scans both A and B, and pressing [UP] key will move to scan C and D range in this case. The “S” on the display flashes during the Search Scan. Press PTT to stop scanning.

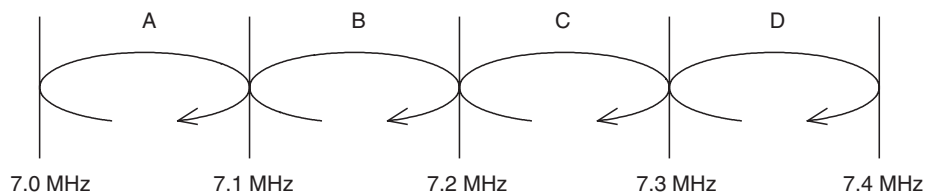

### Memory scan

- This scan searches for signals in programmed memory channels by numerical order.
- Unprogrammed memory channels will be skipped.

It scans only programmed memory channels. Pressing the [▲] key or the microphone’s [UP] key will scan upwards and pressing the [▼] key or the microphone’s [DOWN] key will scan downwards through the channels.

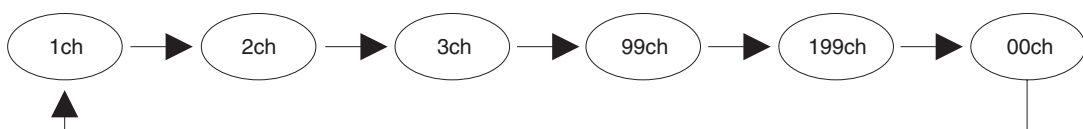

## Priority Scan

- The transceiver receives signals on a VFO or a memory channel for 5 seconds, and then scans a memory or a VFO you specified for 0.5 seconds (2 seconds if squelch is unmuted).

	Display frequency (5 seconds)	Priority frequency (0.5 seconds)
VFO A priority	VFO A	Memory
VFO B priority	VFO B	Memory
Memory priority A	Memory	VFO A
Memory priority B	Memory	VFO B

## Scanning conditions

Details of each scan operation will be explained starting from the next page. But before passing to the scan operation. Please understand the scan resume and starting conditions as follows.

### Scan modes

Band scan, Programmed scan and Memory scan modes have specific condition for stopping and resuming scanning. Please refer to the Page 73 Menu 03 for details.

### To Start scanning

There are 2 ways to start the Band, Programmed, or Search scans. Pre-select the scan mode in the Set mode, or select the mode every time before scanning.

1. Select either one of Band scan, Program scan, Search scan or “select” in the Menu 04 of the Set mode on Page 74 before scanning.
2. Other than the “Select” parameter, the respective scan mode will start by pressing [FUNC] then [8] key in the operation mode.
3. When the “Select” is set, a list of scan mode will appear on the display by pressing [FUNC] then [8] key. Use [▲/▼] keys or rotating the main dial to select the mode you prefer and press [8] again to start scanning.

## 4.2 Band Scan

By setting the Band scan in the Set mode Menu 04 (Page 74):

1. Enter to either the VFO A or B in the VFO mode.
2. Press the [FUNC] key, then press the [8] key to start scanning. During this scan mode, the decimal points flash as shown.
3. Use the [▲/▼] or [UP/DOWN] keys to change the scan direction. Press any key (other than the [▲/▼] and [UP/DOWN] keys) to exit.

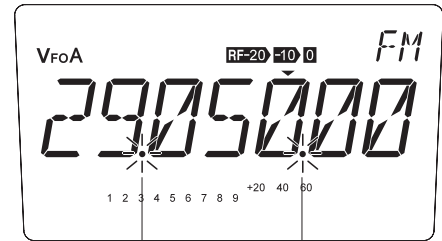

Flash while scanning is in progress.

- NOTE:**
- In the SSB or CW mode, the scan is not likely to pause at a frequency where the received sound is clear. By setting the resumption time long enough, you can fine-tune the frequency using the RIT control knob while the scan pauses.
  - The scan proceeds to the upper limit of the band and returns to the lower limit of the band, or vice versa.
  - Set the frequency step according to the band and modulation mode used there. For example, select a 10 kHz step in 29 MHz FM band.

## 4.3 Programmed Scan

By setting the Programmed scan in the Set mode Menu 04:

1. Enter to the VFO A or B in the VFO mode. Be sure that the P1/P2 channels are correctly programmed in the memory channels prior to use this scan mode.
2. Press the [FUNC] key, then press the [8] key to start scanning. During this scan mode, the decimal point and “P” flash as shown.

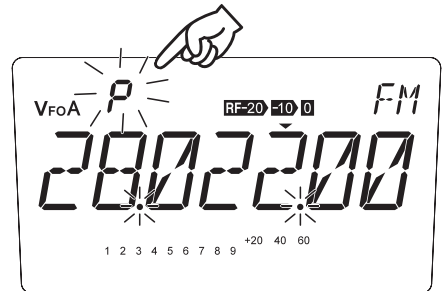

3. Use the [▲/▼] or [UP/DOWN] keys to change the scan direction. Press any key (other than the [▲/▼] and [UP/DOWN] keys) to exit.

**NOTE:** Regardless of the current VFO frequency, the scanning range will be set in the VFO automatically when the scan starts.

## 4.4 Search Scan

By setting the Search scan in the Set mode Menu 04 and 100 kHz in the Menu 05:

1. Enter to either the VFO A or B in the VFO mode.
2. Set any frequency to scan in 100 kHz range and the modulation mode you desire.
3. Press the [FUNC] key, then press the [8] key to start scanning. During this scan mode, the decimal point and “S” flash as shown.

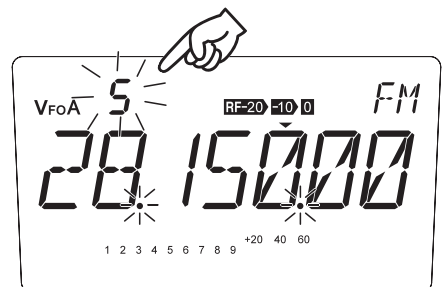

4. Use the [▲/▼] or [UP/DOWN] keys to change the scan direction. Press any key (other than the [▲/▼] and [UP/DOWN] keys) to exit.

## 4.5 Memory Scan

To scan the memory channels stored in the selected memory bank:

1. Enter to either one of the memory banks. The memory indication appears like an example on upper left corner of the display.
2. Press the [FUNC] key, then press the [8] key to start scanning. During this scan mode, the decimal points flash as shown.

This is an example. Actual memory channel number may vary.

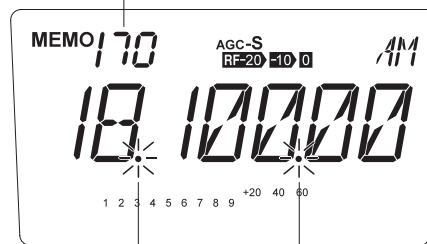

Flash while scanning is in progress.

3. Use the [▲/▼] or [UP/DOWN] keys to change the scan direction. Press any key (other than the [▲/▼] and [UP/DOWN] keys) to exit.

## 4.6 Skip-channel Setting

Memory channels that are set as skip-channels will be excluded from scanning during Memory Scan. This designation can be set even after the memory is programmed.

1. Press the [FUNC] key in the Memory mode, and then press the [V/M] key while the FUNC icon is displayed. Skip setting of a memory channel selected is now in place. A decimal point will appear as shown when skip channels are set.

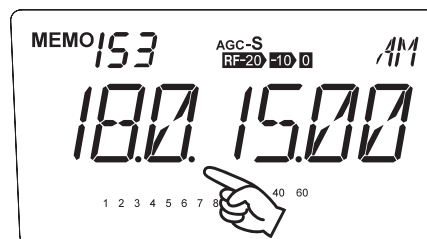

**NOTE:** The same decimal point will appear when the alphanumeric tag is set.

2. To cancel the skip-channel setting, repeat the step 1.

**IMPORTANT:** P1 and P2 are always skipped.

## 4.7 Priority Scan

You can monitor 2 frequencies every 5/0.5 seconds alternatively. Any combination of VFO and / or memory channel frequency can be coupled for priority monitoring. Stay tuned to the main frequency you wish to monitor for 5 seconds, and select the priority frequency (or channel) to monitor 0.5 seconds (and stay there for 2 seconds if a signal is picked up).

Example: Receiving the VFO A and monitoring a memory channel as a priority channel.

1. Enter to the memory mode and select a channel to monitor as a priority.

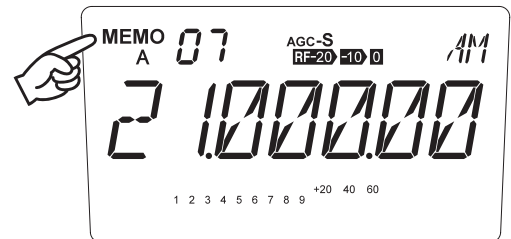

2. Press the [V/M] key to enter to the VFO mode and tune to a frequency you wish to monitor for 5 seconds.

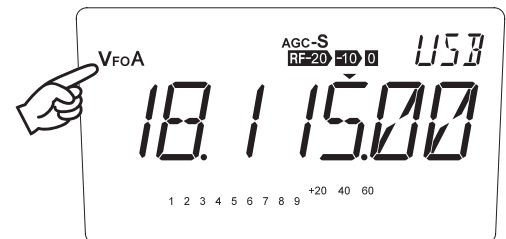

3. Press the [FUNC] key, then press the [6] key to start the priority monitoring. Press any key (other than the [▲/▼] and [UP/DOWN] keys) to exit.

# Chapter 5 Special Functions

## 5.1 Interference Reducers

### Introduction

As explained in previous chapters, this transceiver has built-in functions to reduce interferences. This section explains how to use these functions to reduce interference in detail, although you may be already familiar with these features.

### IF SHIFT

The IF SHIFT function is used to shift the IF pass band without changing the receive frequency. If there is an interference signal near the received signal, rotate the  $\Delta$ IF control knob to get the interference signal out of the receive band.

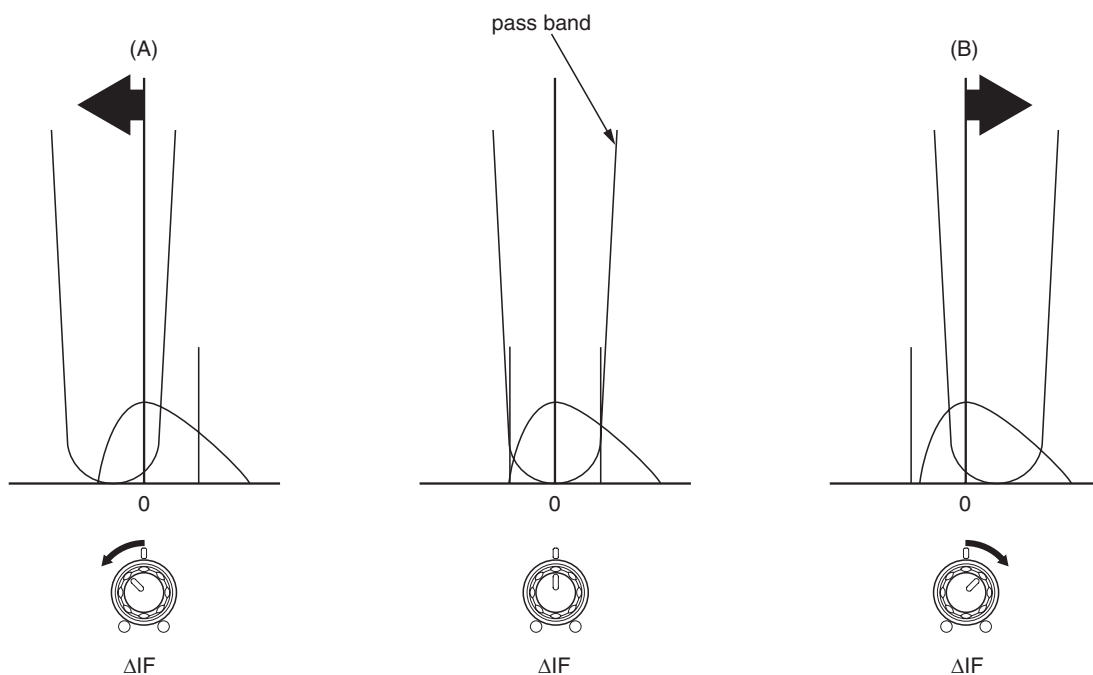

- NOTE:
- This function can shift the IF pass band within a range of only  $\pm 1.5$  kHz.
  - This function will be disabled in the AM and FM modes.
  - This function can also be used to adjust the audio quality to suit your preferences.



## Narrow Filter

The narrow filter can be used in AM, SSB and CW mode. This allows you to effectively reduce interference.

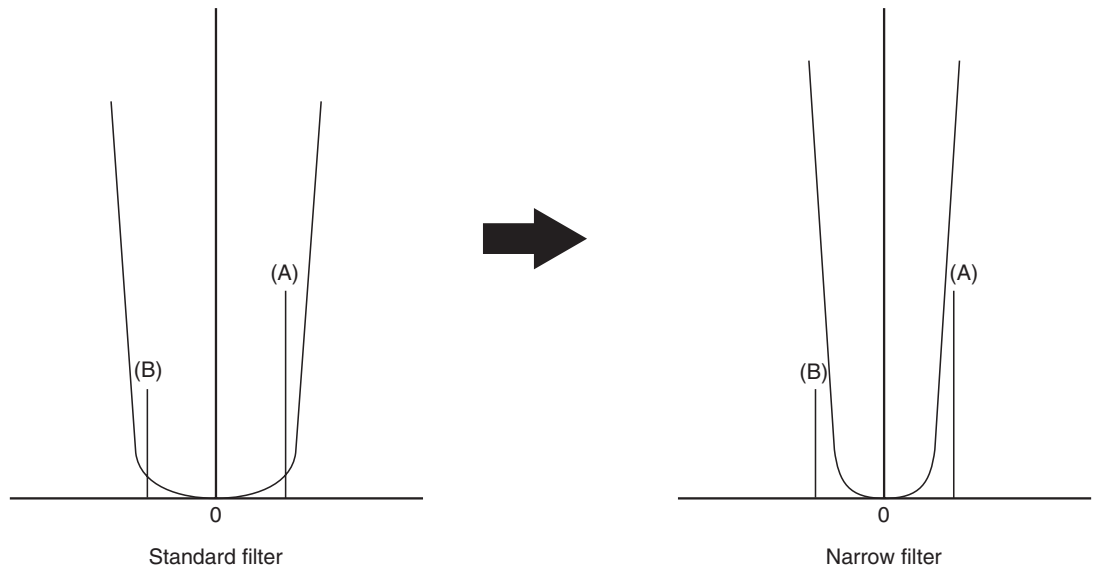

- If there are interference signals (A) and (B) when the standard filter is used, using the narrow filter will reduce the interference.

NOTE: Using the narrow filter will change the audio slightly.

- Filter bandwidth

	Standard	Narrow
CW	1.0	0.5
SSB	2.4	1.0
AM	9	2.4
FM	9	

1. Press the [FUNC] key then press the [RF] key.
  - “Nar” appears on the LCD display.
2. Repeat the same sequence to switch between the Standard/Narrow filters.
  - To clarify the received signal, use the  $\Delta$ IF function together.

NOTE: Use of narrow filter may result in poorer performance to operate some data-modes. Be mindful to switch the filter according to your operation mode.

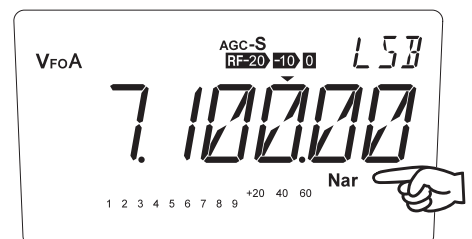

## CW BFO REVERSE

The CW mode has CWU (upper sideband) and CWL (lower sideband) options. Selecting the CWU or CWL can help reduce interference.

When your receive frequency is zeroed-in with the other station's transmit frequency, this function would not affect the receive tone or transmit frequency.

1. Press the [MODE] key to select the CWU or CWL mode.  
Or, press and hold the [MODE] key to flash MODE. Select the mode using the [ $\blacktriangle$ / $\blacktriangledown$ ] keys or the microphone [UP/DOWN] keys. Any key operation stops flashing the mode display.

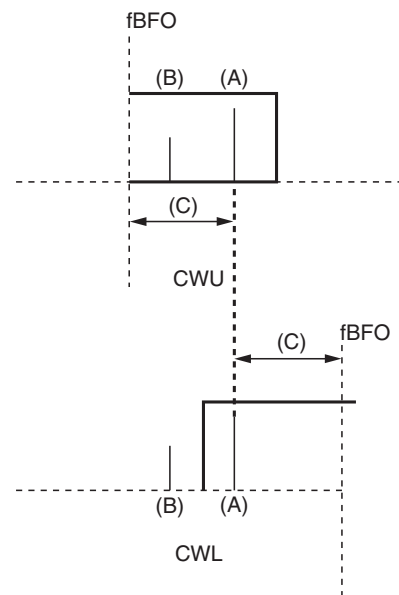

- (A) Desired signal
- (B) Interference signal
- (C) Reception pitch

## NB (Noise Blanker)

The noise blanker suppresses pulse noise generated by car ignition etc to clarify the receiving signal.

1. Press the [FUNC] key then press the [9] key. The "NB" icon will be displayed.

NOTE: Do NOT leave this function activated always. As a side-effect, adjacent strong signals may cause interferences to your receiving frequency.

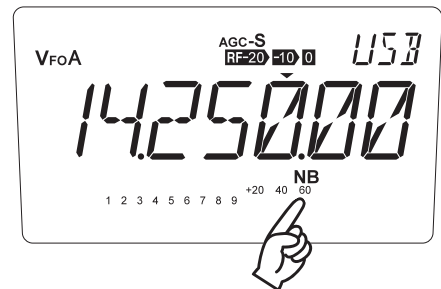

## 5.2 Other Useful Functions

### RIT/TXIT Function

#### RIT/TXIT Function

Once the communication is established, instead of using the main dial, RIT and TXIT are used to fine-tune the operating frequencies during the communication.

RIT is the feature to vary your receiving frequency only without changing the transmitting frequency, TXIT is vice versa. RIT is useful to fine-tune to the receiving signal per your preference, while TXIT is used to help your communicating station's reception of your signal while you stay tuned to his frequency.

Both features vary the frequencies within the range of  $\pm 1.2$  kHz. RIT/TXIT can be used together or separately.

#### Procedure

1. Press the [RIT] key.  
The displayed icon will change in the following manner:

RIT → RIT/TXIT → TXIT → OFF (not displayed)

2. Rotate the RIT control knob to adjust the receive/transmit frequency.

**NOTE:** The TXIT function can be disabled in the Set mode.

**IMPORTANT:**

- Never operate the main dial while you are using RIT/TXIT functions. It will change the original operating frequency causing interferences to adjacent stations or off-frequency from your communicating station. Be extra-cautious always to exit from RIT/TXIT operation before start using the main dial.
- $\pm\Delta F$  feature explained in the following section is another very useful way to exit from RIT/TXIT and start operating with the main dial.

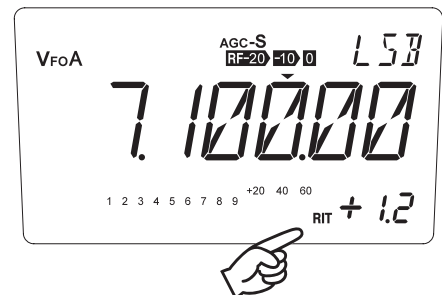

Displays the mode and RIT/TXIT shift frequency while this feature is activated.

## ±Δf (Plus-Minus Delta F) Function

This feature adds current RIT/TXIT values to the original operating frequency and exits from the RIT/TXIT function. This is useful when your communication frequency is established and RIT/TXIT is no longer necessary.

### Procedure

1. While operating RIT/TXIT, press [FUNC] key.
2. Press the [RIT] key to complete the procedure. RIT/TXIT icon disappears.

**NOTE:** Observe the RIT value shown with a finger. It indicates +1.1, but actually it could be any number between 1.10 to 1.19 kHz, because of the frequency display resolution. Therefore like in this example, instead of being added by 1.00 kHz exactly, 1.15 kHz may be added to the original frequency respecting the actual RIT/TXIT values.

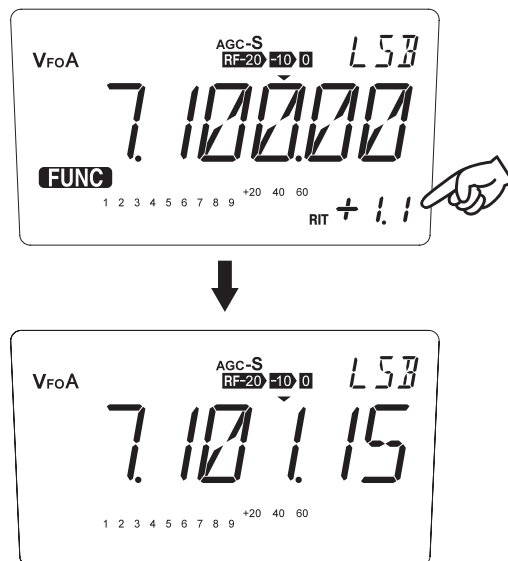

## VFO A=B Function

This function copies the VFO setting A to B or vice versa.

**NOTE:** This is useful when you wish to move to another similar operating condition by just slightly changing some settings, leaving the original status, or switch between these 2 conditions.

### Procedure

1. Set the VFO as you desire.
2. Hold the [V/M] key for more than one second. A beep sounds (but nothing changes on the display). Press the [FUNC] then press the [1] key to copy the VFO status to another VFO and remain there.

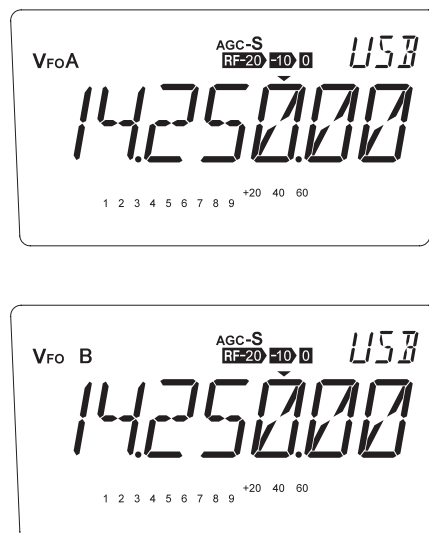

## MULTI FUNCTION Feature

Any key operation can be assigned to the [MF] key as a short-cut.

\* All key functions and Set mode parameters can be assigned to this feature except [PTT] key operation.

Example: Assign the scan speed setting in the Set mode to the [MF] key.

1. Press the [FUNC] key, then press the [MF] key. The ★ icon flashes.

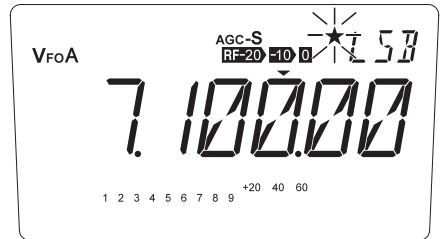

2. Press the [FUNC] key for more than 1 second. "SET" will appear indicating the transceiver is in the Parameter Setting mode.

3. Select the timer scan setting menu by pressing the [▲/▼] keys.  
\* See Menu 03 on page 73 to select the timer scan setting.

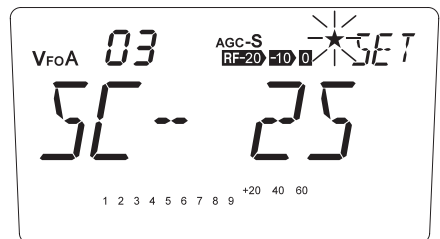

4. Press any key other than [▲/▼] key.
5. Press the [MF] key. The ★ stops flashing.

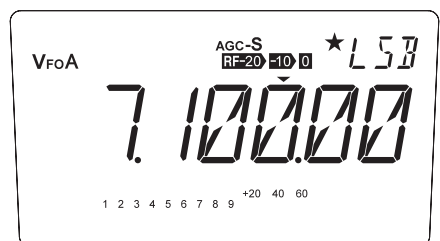

6. Press the [MF] key, the display show the timer scan setting menu.

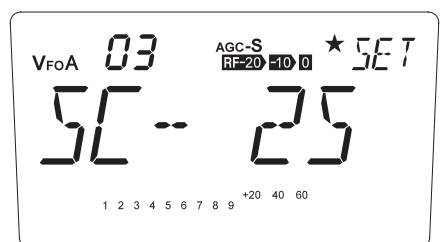

\* You can assign different functions at any time you may so wish by just repeating above procedure.

## DIAL LOCK Function

This function locks the main tuning dial to prevent accidental frequency changes.

**NOTE:** This function is useful in mobile operation where the main tuning dial may be rotated by car vibrations, etc. While this function is activated, tuning is still possible with the [▲/▼] keys and RIT control knob.

### Procedure

1. Press the [🔒] key.  
 🔒 will appear.  
 • To cancel this function, press the [🔒] key again.

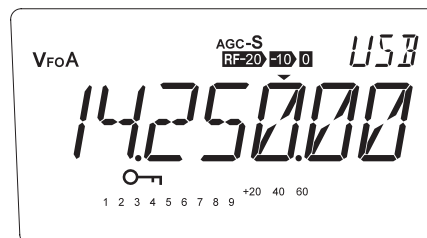

## KEY LOCK Function

Key lock function blocks operations of the main dial and most of other key operations. In the Key-lock status, only the following operations are permitted other than the Power ON/OFF and the [FUNC] key operation.

[Functions permitted during the Key-lock]

- PTT • AF level • Squelch level • IF shift • RIT/TXIT (if activated in advance)

1. Press the [FUNC] key, then press the [🔒] key.
2. 🔒 will flash.  
 • To cancel this function, press the [FUNC] key, then press the [🔒] key again.

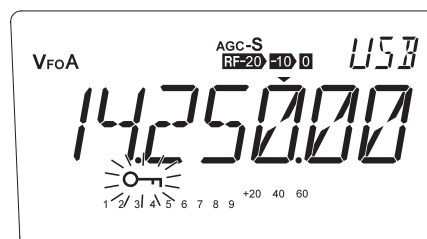

## CABLE CLONE

This feature will copy the programmed data and parameters in the master unit to slave units. It copies the parameters and memory program settings.

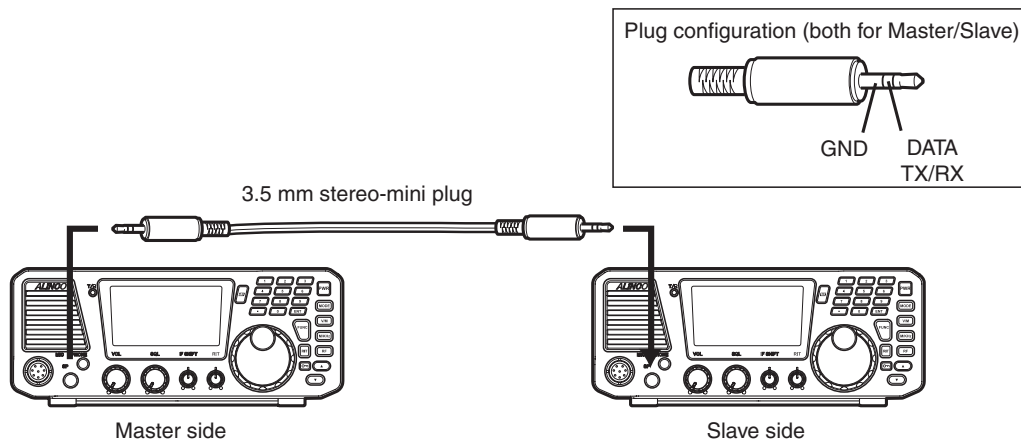

### Connection

Make a cable using 3.5 mm stereo-mini plugs as shown above. Make a master unit by setting and programming it as desired. Turn off both units. Connect the cable between the Speaker jacks on both master and slave. Turn both radios on after the connection is made.

**IMPORTANT:** Be sure to connect cables while the units are turned OFF.

### [Slave side]

1. Go to receive mode (VFO or Memory) and stand-by.
2. When the cloning starts, LD\*\*\* shows up on the display.
3. When the cloning is successfully completed, the display will show [PASS].
4. Turn off the power. Disconnect the cable and repeat the sequence to clone the next slave unit.

### [Master side]

1. Turn the power on while pressing the [MODE] key. CLONE will be displayed and the radio enters the clone mode.
2. Press PTT. SD\*\*\* will be displayed and it starts sending the data into the slave unit.
3. [PASS] will appear on the display when the data is successfully transmitted.
4. The master unit may stay turned on for the next clone, or turn off the unit to exit from the clone mode.

If the data is not successfully transmitted, [ERROR] will appear on the display. Turn off both units, make sure the cable connection is correct and repeat the entire operation from the beginning. If you quit the operation in condition that the clone is incompleting, please ALL-reset the slave unit by referring to P.87.

# Chapter 6 Parameter Setting Mode (Set mode)

**IMPORTANT:** Please read the following pages thoroughly prior to the change of any parameters. THE PARAMETERS CANNOT BE SET WITHOUT ENTERING THE SET MODE.

By entering the Parameter Setting mode, some of the radio's operating parameters can be changed to suit your preferences. The following is the Selectable Parameters' Menu.

## A List of the Setting Mode Parameters

Menu	Default display	Function	Default Value
00	SSB-0.1	Frequency Step of the [▲/▼] Keys Setting	0.1 kHz
	AM-1.0		1.0 kHz
	FM-2.5		2.5 kHz
01	PROT-OFF	Memory Overwrite Protection	OFF
02	ACCS-ON	Memory Frequency Access Protection	ON
03	SC- 2S	Timer SCAN Setting	2S
04	B-SCAN	Select Scan types	BAND SCAN
05	SSC-50	Search range setting for Search scan	50 kHz
06	SKIP	Memory scan skip Setting	SKIP
07	DIMR-32	Dimmer	32
08	BEEP-ON	Beep Sound	ON
09	U/L-ON	Automatic USB / LSB Selection	ON
10	AGC-ON	Automatic AGC-S / AGC-F Selection	ON
11	TXIT-ON	TXIT Function Setting	ON
12	EKEY-ON	Electronic Keyer Setting	ON
13	WPM-20	Electronic Keyer Speed Setting	20 WPM
14	PADDL-N	Electronic Keyer Reverse Setting	PADDLE-N
15	ST-800	Sidetone (CW Offset) Setting	800 Hz
16	BKIN-AT	Break-in Delay Time for CW operation	AUTO
17	RAT-3.0	Key ratio	3.0
18	T-88.5	CTCSS Tone Encoding Setting	88.5 Hz
19	SPH-OFF	Speech Compressor	OFF
20	PTT.L-OF	PTT Key Lock	OFF
21	APO-OFF	APO-Auto Power OFF	OFF
22	UD-RPT	UP/DOWN keys function setting	REPEAT
23	FUNC-MN	FUNC key resume timing setting	MANUAL

## To Use the Parameter Setting Mode

1. Press [FUNC] key for more than 1 second. Alphanumeric characters will appear indicating the transceiver is in the Parameter Setting mode. Please observe the menu number to understand which parameter you are currently dealing with.
2. Select a menu by pressing the [▲/▼] keys, or [UP/DOWN] keys on the microphone.
3. Rotate the main dial to change the desired setting. In case the available parameter is 2 items, such as ON/OFF, rotate the dial clockwise or counterclockwise to select either one.



4. Press [ $\blacktriangle$ / $\blacktriangledown$ ] or [UP/DOWN] keys again to set the selected parameter and move to the next programming.
5. Press any key other than [ $\blacktriangle$ / $\blacktriangledown$ ] or [UP/DOWN] keys to set the selected parameter and exit from the Parameter setting mode. A beep sounds.

## Menu 00. Frequency Step of the [ $\blacktriangle$ / $\blacktriangledown$ ] Keys Setting

\* You should select the modulation mode in advance then enter to the Set mode to change the parameter in this menu.

### • SSB and CW Modes

1. While the unit is in SSB or CW mode, enter into the Set mode and select menu 00.
2. The current frequency step will be displayed.
3. You can change the frequency step as below by rotating the main dial.

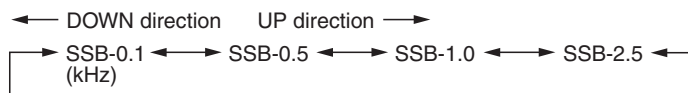
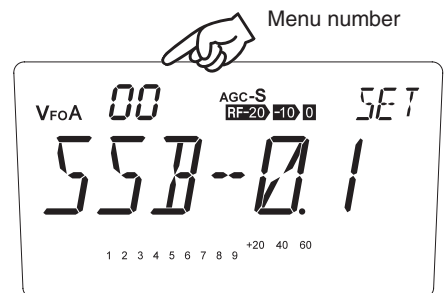

### • AM Mode

1. While the unit is in AM mode, enter into the Set mode and select menu 00.
2. The current frequency step will be displayed.
3. You can change the frequency step as below by rotating the main dial.

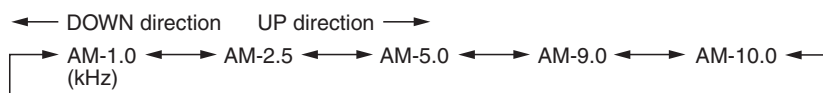
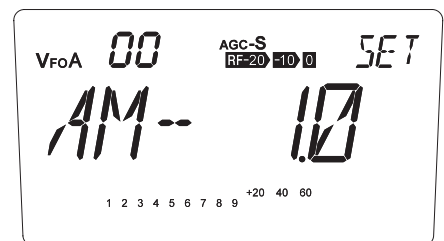

• **FM Mode**

1. While the unit is in FM mode, enter into the Set mode and select menu 00.
2. The current frequency step will be displayed.
3. You can change the frequency step as below by rotating the main dial.

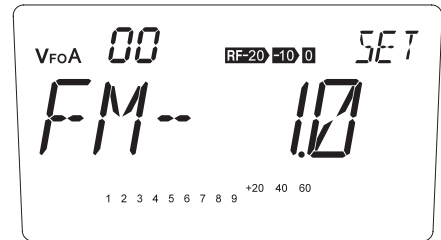

## Menu 01. Memory Overwrite Protection

This function protects all memory channels from accidental overwriting.

1. The [PROT-OF] appears on the display. (Default)
2. Turn the main dial clockwise, the display changes into the [PROT-ON] and the Memory Overwrite Protection is activated.

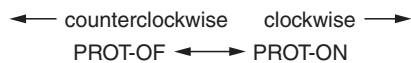
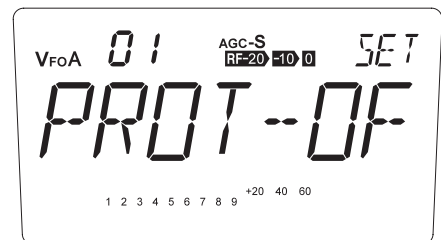

**NOTE:** The feature determines only allows or prohibits “memory overwrite”. Memory data erase is still possible regardless of this parameter.

## Menu 02. Memory Frequency Access Protection

Memory frequencies can be temporary changed by using main dial etc. during the operation. However, by selecting ACCS-OF here, the memory frequency can't be changed except by using RIT/TXIT. This is not a key-lock therefore you can still temporary alter other functions in memory like output, mode, RF gain etc. even OF is selected.

1. The [ACCS-ON] appears on the display.  
(Default)
2. Turn the main dial counterclockwise, the display changes into the [ACCS-OF] and the Memory Frequency Access Protection is changed.

← counterclockwise    clockwise →  
ACCS-OF ← → ACCS-ON

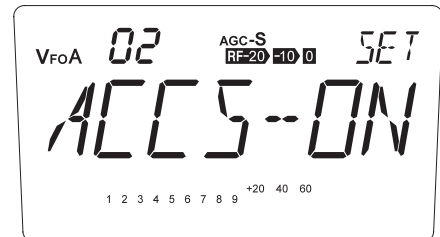

## Menu 03. Timer SCAN Setting

Each Scan mode has specific condition for stopping and resuming scanning. Select one of the conditions below for your scan operation.

1. The current timer scan setting will be displayed.

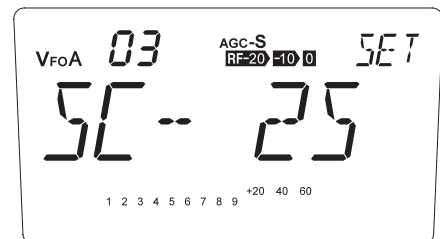

2. You can change the scan condition as below by rotating the main dial.

→ SC-OFF ← → SC-0 ← → SC-1S ← → SC-2S ... SC-B0 ... SC-B1M ... SC-B30M ←

- |     |      |   |
|-----|------|---|
| (A) | OFF: | Stops scanning when a signal is picked up, and quits scanning.                                |
|     | 0:   | Stops scanning when a signal is picked up, and will resume scanning after the signal is gone. |
|     | 1S:  | Stops scanning when a signal is picked up, and will resume scanning after 1 second.           |
|     | 2S:  | Stops scanning when a signal is picked up, and will resume scanning after 2 seconds.          |
|     | 3S:  | Stops scanning when a signal is picked up, and will resume scanning after 3 seconds.          |
|     | 5S:  | Stops scanning when a signal is picked up, and will resume scanning after 5 seconds.          |
|     | 7S:  | Stops scanning when a signal is picked up, and will resume scanning after 7 seconds.          |
| (B) | 10S: | Stops scanning when a signal is picked up, and will resume scanning after 10 seconds.         |
|     | B0:  | Will not stop scanning even when signals are picked up.                                       |
|     | B1S: | The scan stops regardless of a signal by all means, and will resume scanning after 1 second.  |
|     | B2S: | The scan stops regardless of a signal by all means, and will resume scanning after 2 seconds. |
|     | B3S: | The scan stops regardless of a signal by all means, and will resume scanning after 3 seconds. |
|     | B5S: | The scan stops regardless of a signal by all means, and will resume scanning after 5 seconds. |

- (B)
- B10S: The scan stops regardless of a signal by all means, and will resume scanning after 10 seconds.
  - B20S: The scan stops regardless of a signal by all means, and will resume scanning after 20 seconds.
  - B30S: The scan stops regardless of a signal by all means, and will resume scanning after 30 seconds.
  - B1M: The scan stops regardless of a signal by all means, and will resume scanning after 1 minute.
  - B2M: The scan stops regardless of a signal by all means, and will resume scanning after 2 minutes.
  - B3M: The scan stops regardless of a signal by all means, and will resume scanning after 3 minutes.
  - B5M: The scan stops regardless of a signal by all means, and will resume scanning after 5 minutes.
  - B10M: The scan stops regardless of a signal by all means, and will resume scanning after 10 minutes.
  - B20M: The scan stops regardless of a signal by all means, and will resume scanning after 20 minutes.
  - B30M: The scan stops regardless of a signal by all means, and will resume scanning after 30 minutes.

NOTE:

- (A) conditions require the squelch to be muted during the scan. The B0 parameter does not stop scanning automatically therefore you need to press one of the keys like [PTT] key to stop it manually.
- (B) conditions does not require the squelch to be muted, as the scan resumes by elapsed time regardless of the presence of the signal.

## Menu 04. Select Scan types

3 scanning modes are available in VFO mode. Selected scanning will be performed in VFO mode.

1. The default mode is [B-SCAN].
2. Rotate the main dial to select the scanning mode.

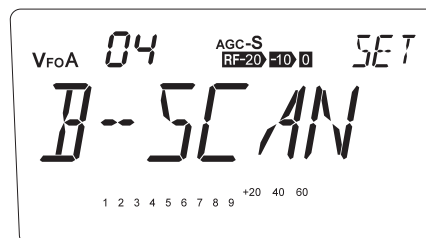

B-SCAN	...	band Scanning
P-SCAN	...	Programmed scanning
S-SCAN	...	Search scanning
SELECT	...	You can select the scan mode manually before start scanning.

## Menu 05. Search range setting for Search scan

This is to set the scanning range applied to Search scanning. 50, 100 and 200 kHz are available as parameters.

1. Default range is [SSC-50].

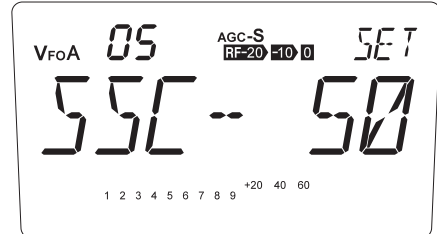

2. Rotate the main dial to select the scanning range.

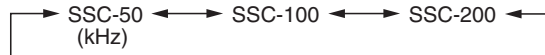

## Menu 06. Memory scan skip Setting

This is to select either to include or exclude the memory-skip channels during the memory-scanning.

1. Default is [SKIP].

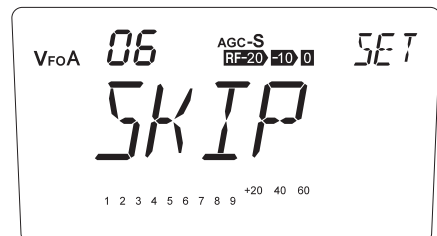

2. Rotate the main dial counterclockwise to select [NO SKIP].

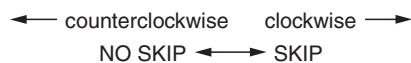

- [SKIP] ... Excludes skip channels during the memory scanning.  
 [NO SKIP] ... Includes skip channels during the memory scanning.

## Menu 07. Dimmer

The LCD illumination dimmer is available to adjust the luminosity of the display as you prefer.

1. The [DIMR-32] appears on the display.  
(Default)

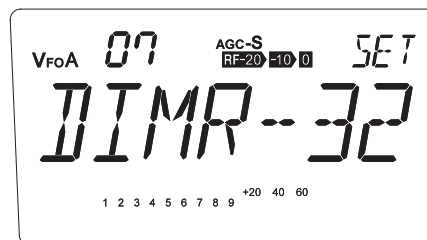

2. By rotating the main dial, the display changes as shown and the luminosity changes. The brightest is 64 and will be darker as number decreases. DIMR-00 turns off the illumination.



## Menu 08. Beep Sound

If “ON” is selected, a high-pitch beep will be heard each time a valid key is pressed, and a low-pitch beep will be heard each time an invalid key is pressed. “OFF” mutes all beep sounds.

1. The [BEEP-ON] appears on the display.  
(Default)
2. Turn the main dial counterclockwise, the display changes into the [BEEP-OFF] and mutes the beep.

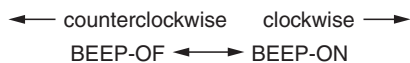
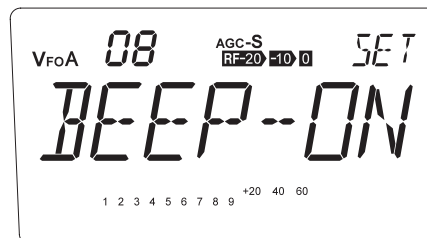

## Menu 09. Automatic USB/LSB Selection

This function automatically selects the USB or LSB mode depending on which amateur radio band has been selected in SSB mode. If “OFF” is selected, the last-used SSB mode is recalled regardless of the band.

1. The [U/L-ON] appears on the display.  
(Default)
2. Turn the main dial counterclockwise, the display changes into the [U/L-OFF] to select USB/LSB manually.

← counterclockwise      clockwise →  
U/L-OFF ←→ U/L-ON

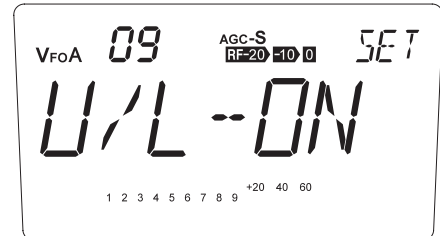

**NOTE:** Even ON is set, manual selection of USB/LSB is still possible during the operation but returns to automatic when the power is turned off.

## Menu 10. Automatic AGC-S/AGC-F Selection

This function allows automatically select the AGC-S or AGC-F in accordance with the modulation mode.

1. Default range is [AGC-ON].
2. Rotate the main dial counterclockwise to select [AGC-OFF] to set it manually.

← counterclockwise      clockwise →  
AGC-OFF ←→ AGC-ON

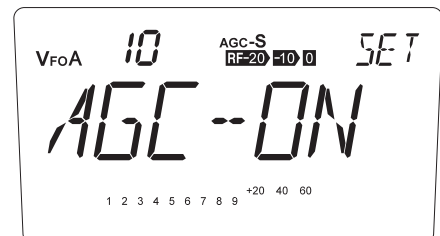

In AGC-ON state, AGC will be automatically selected to:

SSB, AM ... AGC-S  
CW ... AGC-F

**NOTE:** A manual selection of AGC is still possible even the parameter is set to ON position by operating [FUNC] and [M/KHz] key. It resets to automatic when the power is turned off.

## Menu 11. TXIT Function Setting

This is to allow/prohibit the access to TXIT. If “OF”(OFF) in selected, only an RIT function works.

1. The [TXIT-ON] appears on the display.  
(Default)
2. Turn the main dial counterclockwise, the display changes into the [TXIT-OFF] and only an RIT function works.

← counterclockwise      clockwise →  
TXIT-OFF ↔ TXIT-ON

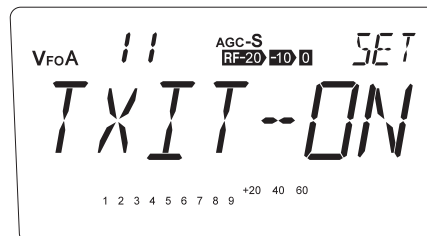

NOTE: TXIT icon won't appear by operating in this state.

## Menu 12. Electronic Keyer Setting

This function offers automatic dot and dash keying functions for speedy CW transmission. When [EKEY-OF] is selected, it works in semi-automatic mode that can key only dots, while dashes should be emitted manually, i.e. the dash contact works as straight key. When [EKEY-ON] is selected, both dots and dashes are keyed automatically by manipulating each respective contacts.

1. The [EKEY-ON] appears on the display.  
(Default)
2. Turn the main dial counterclockwise, the display changes into the [EKEY-OFF] and it works in semi-automatic mode.

← counterclockwise      clockwise →  
EKEY-OFF ↔ EKEY-ON

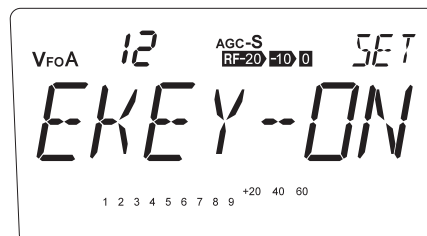

## Menu 13. Electronic Keyer Speed Setting

This function is effective at the [EKEY-ON] (Refer to menu 12 above). It changes Electronic Keyer speed in a range of 6 to 40 wpm.

1. The [WPM-20] appears on the display.  
(Default)
2. By rotating the main dial, the display changes as shown and the Electronic Keyer speed is changed.

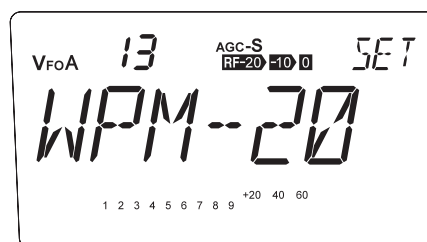

→ WPM-6 ↔ WPM-7 ... WPM-20 ... WPM-39 ↔ WPM-40 ←



## Menu 14. Electronic Keyer Reverse Setting

When Electronic Keyer setting is ON (Refer to menu 12), you can change the dots and the dash keying positions (left and right strokes).

1. Default is [PADDL-N] and operates in normal position.
2. Turn the main dial clockwise, the display changes into the [PADDL-R] and reverses the position.

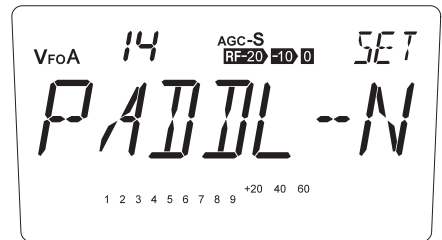
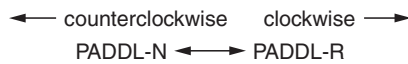

## Menu 15. Sidetone (CW Offset) Setting

The sidetone will change according to the CW offset you select.

1. The [ST-800] appears on the display. (Default)

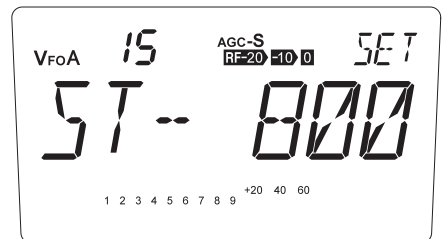

2. By rotating the main dial, the display changes as shown and the sidetone is changed.

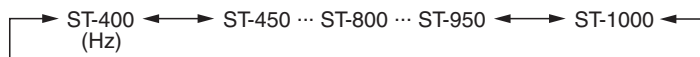

## Menu 16. Break-in Delay Time for CW operation

You can select from AUTO BREAK-IN, SEMI BREAK-IN (selectable in 7 steps), and FULL BREAK-IN.

1. The current Break-in setting appears on the display.

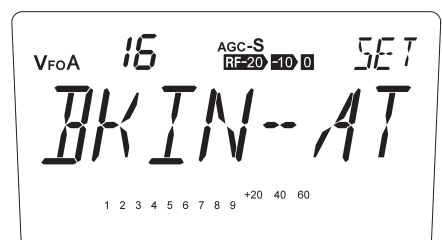

2. You can change the break-in types as below by rotating the main dial.

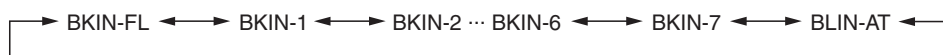

- **AT (AUTO)**

The delay time for the SEMI BREAK-IN mode will be set automatically according to the code speed being transmitted.

- **1 to 7**

Select the desired delay time for the SEMI BREAK-IN mode (“1” is the shortest, and “7” is the longest).

- **FL (FULL)**

The FULL BREAK-IN mode.

## Menu 17. Key ratio

This menu sets the CW key ratio (or weight).

1. Default range is [RAT-3.0].

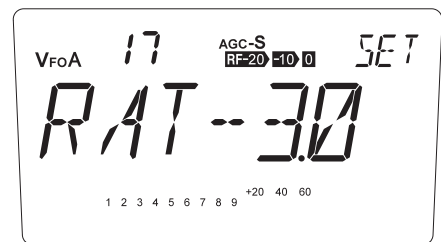

2. You can change the Key ratio as below by rotating the main dial.

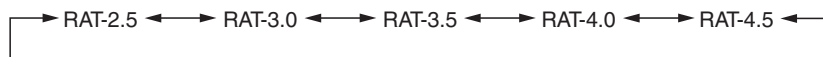

## Menu 18. CTCSS Tone Encoding Setting

The CTCSS tone, sometimes called PL tone, is a sub-audible tone superimposed on your voice. It is used for repeater uplink on 29 MHz FM band. There are 39 types of tones. The tone setting is activated only in FM mode.

1. The current Encoding setting appears on the display.

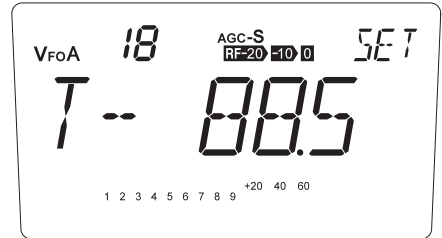

2. You can change the CTCSS tone frequency as below by rotating the main dial.

67.0	69.3	71.9	74.4	77.0	79.7	82.5	85.4
88.5	91.5	94.8	97.4	100.0	103.5	107.2	110.9
114.8	118.8	123.0	127.3	131.8	136.5	141.3	146.2
151.4	156.7	162.2	167.9	173.8	179.9	186.2	192.8
203.5	210.7	218.1	225.7	233.6	241.8	250.3	

CTCSS Tone Frequency (Hz)

## Menu 19. Speech Compressor

The speech compressor increases talk power. This is useful for transmission in the SSB and AM under poorer communication condition.

1. Default is [SPH-OFF].

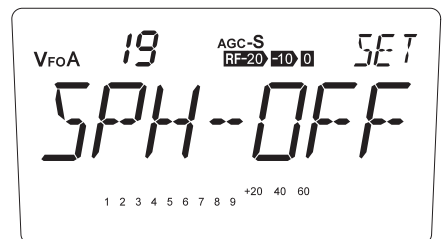

2. By rotating the main dial clockwise, select [SPH-ON] or [ALL].

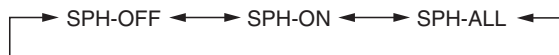

- \* SPH-ON activates processor in SSB and AM modes. SPH-ALL activates FM mode in addition to SSB and AM. Select this parameter only when you need to amplify the talk power of FM for some special reason.
- \* Talking close to the microphone, too loud or using linear amplifier while compressor is ON, the modulation may be distorted or transmits splatters to bother other communications.
- \* Turn off the processor to operate in digital modes like RTTY etc.

## Menu 20. PTT Key Lock

This is to deactivate the PTT key.

1. Default is [PTT.L-OFF].

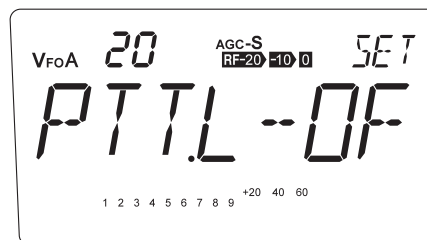

2. Turn the main dial clockwise, select [PTT.L-ON] to use DX-SR8 as a receiver.

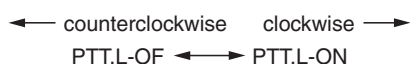

## Menu 21. APO-Auto Power OFF

This feature will automatically shut off the power. If there is no activity or use of the key, it will turn off automatically after a selected time is elapsed followed by a beep sound.

1. Default is [APO-OFF]. Use the [PWR] key to turn on/off the unit.

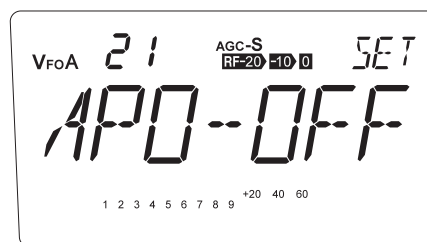

2. By rotating the main dial clockwise, select [APO-ON] to activate the function.



NOTE: APO time won't be reset even operating the following:  
 • AF output • Squelch • IF shift • RIT/TXIT • Main dial

## MENU 22. UP/DOWN keys function setting

Function for pressing [ $\blacktriangle$ / $\blacktriangledown$ ] and UP/DOWN keys on the microphone can be set to starting scanning or a key-repeat to increase/decrease values continuously (and faster) while holding down the key.

1. The default is [UD-RPT] that is key-repeat function.

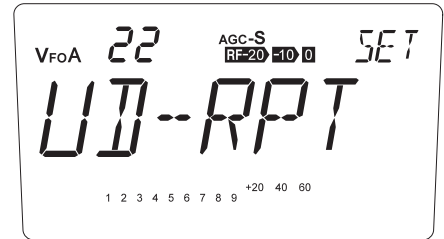

2. Rotate the main dial clockwise to select [UD-SCN]. When SCN is selected, holding down the key will start scanning according to the current operation mode.

← counterclockwise    clockwise →  
UD-RPT ←→ UD-SCN

## MENU 23. FUNC key resume timing setting

The FUNC key resume timing can be set to manual or auto as below:

FUNC-MN (manual resume)...FUNC key operation remains until the next key is pressed.

FUNC-AT (Auto).....FUNC key operation will be canceled automatically and FUNC indication on the display turns off when no operation is performed within 5 seconds.

1. The default is [FUNC-MN].

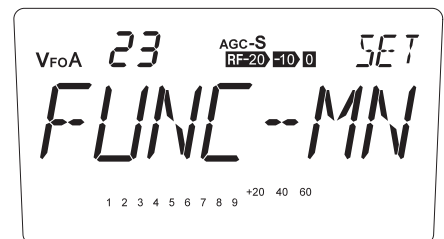

2. Rotate the main dial clockwise to select [FUNC-AT]. Automatic FUNC operation is activated.

← counterclockwise    clockwise →  
FUNC-MN ←→ FUNC-AT

# Chapter 7 Maintenance

## 7.1 Adjustment

### Introduction

DX-SR8 has been strictly tested and completely adjusted at the factory prior to shipment. When adjusting, therefore, be careful not to touch the non-user-servisable components such as the preset resistors/pots, and trimmers inside. Off-alignments caused by a user voids warranty.

### Adjustment Item List

Remove the covers to perform the following:

- Adjusting microphone gain.
- Adjusting beep volume.
- Adjusting sidetone volume.
- Adjusting the output power of S-LOW for QRP operation.
- Selecting 100 W or 50 W output.
- Fuse replacement

**IMPORTANT:** Be sure to turn the POWER switch off and unplug the DC cable before removing the covers.

### Removing the FRONT unit

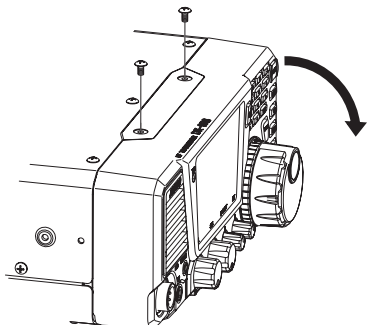

### Removing the Covers

Remove the covers as shown below.

- Top cover

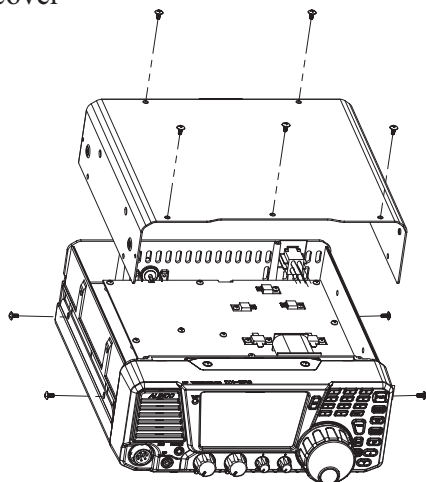

- Bottom cover

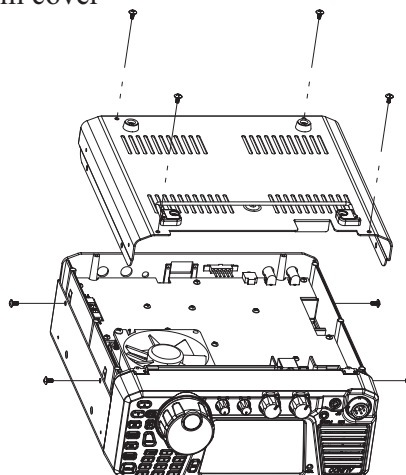

**CAUTION:** The adjustments are strictly at users' risks and any damage to the unit due to failure of adjustments void the warranty. If you are not familiar with the radio maintenance, please consult your local Alinco dealer for technical assistance. S-Low setting requires a power-meter. Use only ceramic driver to deal with the potentiometers.

## Procedure

Adjusting microphone gain : VR117

- Turn clockwise to increase, and turn counterclockwise to decrease.

Adjusting beep volume : VR109

- Turn clockwise to increase, and turn counterclockwise to decrease.

Adjusting side tone volume : VR111

- Turn clockwise to increase, and turn counterclockwise to decrease.

Adjusting the Super-Low output power for QRP operation: VR120

- Turn clockwise to increase, and turn counterclockwise to decrease.

Adjust range is from approx. 0.1 to 2 watts.

Selecting 100 W or 50 W output : I

100 W : Open

50 W : Soldering

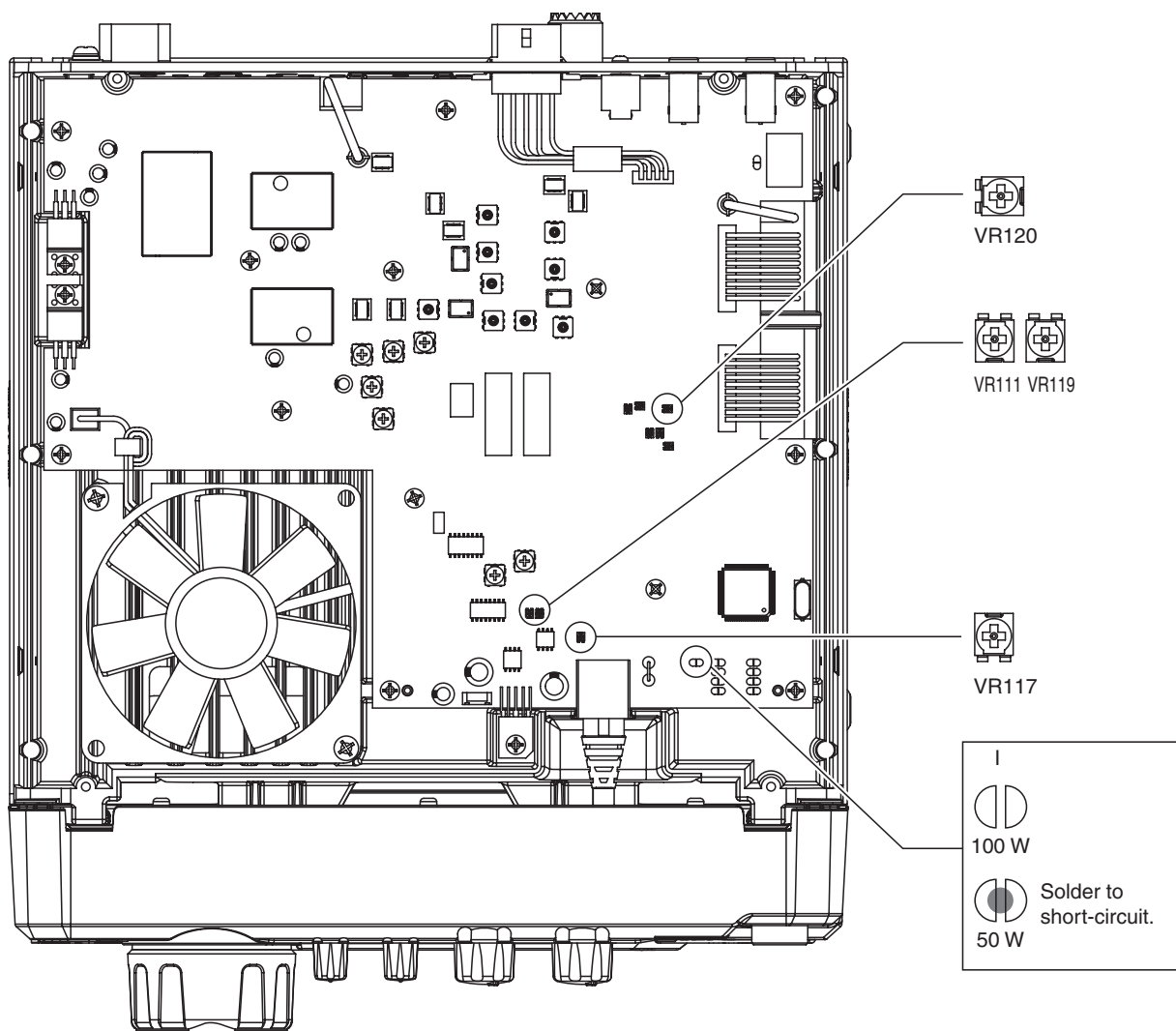

## 7.2 Fuse replacement

If a fuse blows or the unit stops functioning, try to find the source of the problem, and replace the damaged fuse with a new, rated fuse.

**CAUTION:** Disconnect the DC power cable from the transceiver when changing a fuse.

The DX-SR8 has 2 types of fuses installed for transceiver protection.

- DC power cable fuses.....Blade-type 30 A
- Circuitry fuse.....FGMB 5 A

### DC POWER CABLE FUSE REPLACEMENT

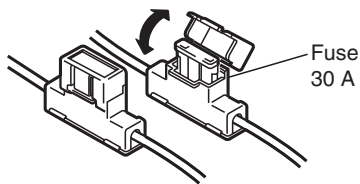

### CIRCUITRY FUSE REPLACEMENT

The 13.8V DC from the power cable is applied to all circuits in the DX-SR8 through the circuitry fuse. This fuse is installed in the PA unit.

1. Remove the top cover as shown on P.84.
2. Replace the circuitry fuse as shown.
3. Close the top cover.

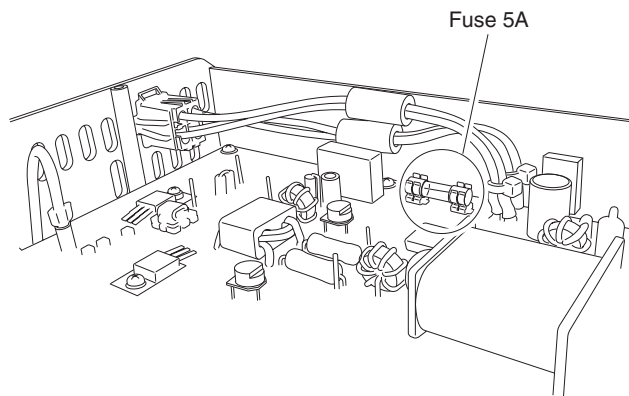



## 7.3 Reset

There are 3 types of reset modes in DX-SR8.

1. ALL reset: Resets all customized parameters and memories to return to the factory-default condition.
2. Memory reset: Resets memory channel data only.
3. System reset: Resets functions and Set mode parameters. Memory data remain unchanged.

### Procedure

- \* ALL reset: Turn off then turn on with [FUNC] key pressed.
- \* Memory reset: Turn off, then turn on with [M/KHz] and [RF] keys pressed together.
- \* System reset: Turn off, then turn on with [V/M] key pressed.

**NOTE:**

- None of reset can restore previous data once the reset is completed. It is recommended to write important setting parameters and/or memory frequency information on blank pages available at the end of this manual for your future references.
- It is recommended to use reset features whenever you get lost with the explanation of this manual until you get familiar with the functions of DX-SR8.

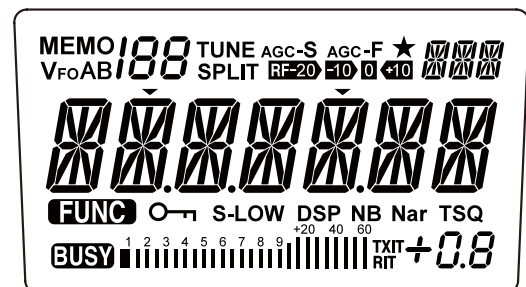

All LCD segments

## 7.4 Cleaning

Regular cleaning is recommended to use this product in appropriate conditions.

- \* Be sure turn off and remove from the power source to clean the product.
- \* Use of cleaning devices made especially for delicate equipment such as personal computer or digital video/camera, like special wet-tissues, anti-static brushes, dry rubber-blower etc. is suitable to clean the surface of this product and accessories also.
- \* Never use thinner, benzene, alcohol or any liquid solvent otherwise damages the product and voids warranty.
- \* Never use unauthorized contact-cleaners, oil, spray-blower and other materials may be used to clean home appliances. They may not be suitable for delicate products like transceivers. Troubles caused by use of such materials will void the warranty of this product.

## 7.5 Troubleshooting

If a problem should occur, first try the troubleshooting procedure given below. If the problem persists, contact your nearest ALINCO dealer for technical assistances.

Symptom	Possible Cause	Remedy
Power does not come on.	<ol style="list-style-type: none"> <li>1. DC power cable is incorrectly connected.</li> <li>2. Fuse is blown.</li> <li>3. Plug polarity is wrong.</li> <li>4. Power switch of DC regulated power supply is off.</li> <li>5. Voltage from the power supply is insufficient.</li> </ol>	<ol style="list-style-type: none"> <li>1. Correctly connect cable.</li> <li>2. Replace fuse. (page 86)</li> <li>3. Correct polarity and replace fuse.</li> <li>4. Turn power switch on.</li> <li>5. Supply a regulated 13.8 V DC <math>\pm</math> 15 %</li> </ol>
LCD display related troubles.	<ol style="list-style-type: none"> <li>1. Power supply voltage is low. To transmit at 100 W output, the power supply must be capable of supplying 30 Amps continuously at 13.8 V DC.</li> <li>2. No illumination.</li> </ol>	<ol style="list-style-type: none"> <li>1. • Check that DC regulated power supply is used. • Adjust the operating voltage within a range of 13.8 V DC <math>\pm</math> 15 % (11.7 to 15.8 V DC).</li> <li>2. Check the Set mode's dimmer setting (P.76)</li> </ol>
No sound from speaker.	<ol style="list-style-type: none"> <li>1. AF control knob is turned fully counterclockwise.</li> <li>2. [PTT] key of microphone is on.</li> <li>3. Telegraph key is in transmission.</li> <li>4. External speaker cable is short-circuited or damaged.</li> <li>5. Headphones or earphone is plugged into the speaker jack.</li> <li>6. Squelch level is set too high.</li> </ol>	<ol style="list-style-type: none"> <li>1. Rotate AF control knob to adjust volume. (page 25)</li> <li>2. Release [PTT] key. (page 33)</li> <li>3. Stop keying with telegraph key. Also check that cable plug is not short-circuited.</li> <li>4. Check cable.</li> <li>5. Unplug headphones or earphone. (page 14)</li> <li>6. Turn SQL control knob counterclockwise to unmute squelch. (page 25)</li> </ol>
Only strong signals are received.	<ol style="list-style-type: none"> <li>1. Squelch is muted.</li> <li>2. ATT is on.</li> <li>3. Defective antenna or short-circuited or damaged coaxial cable.</li> <li>4. Antenna is not suitable for receiving band.</li> </ol>	<ol style="list-style-type: none"> <li>1. Turn SQL control knob counterclockwise. (page 25)</li> <li>2. Press [RF] key to turn ATT off. (page 31)</li> <li>3. Check antenna, cable, and connector. (page 13)</li> <li>4. Connect correct antenna.</li> </ol>
Received signal is not demodulated.	<ol style="list-style-type: none"> <li>1. Wrong mode is set. (If SSB, also check LSB and USB)</li> <li>2. Wrong passband is set.</li> </ol>	<ol style="list-style-type: none"> <li>1. Press the mode key (page 26) to select a correct mode.</li> <li>2. • Turn <math>\Delta</math>IF control knob to a position where proper audio can be heard. (page 62) • Select proper filter. (page 63)</li> </ol>
No frequency change when rotating the main tuning dial.	<ol style="list-style-type: none"> <li>1. Dial is locked.</li> </ol>	<ol style="list-style-type: none"> <li>1. Press [] key to free dial. (page 68)</li> </ol>
Scan does not start.	<ol style="list-style-type: none"> <li>1. Scan setting is incorrect in the Set mode or squelch is unmute.</li> </ol>	<ol style="list-style-type: none"> <li>1. Correct the scan type (p.74) or mute the squelch.</li> </ol>

Symptom	Possible Cause	Remedy
Cannot access Memory mode.	1. Memory channel is unprogrammed.	1. Program memory channel. (page 48)
Memory scan will not start.	1. Memory channel is unprogrammed.	1. Program memory channel. (page 48)
Memory channel cannot be re-programmed.	1. Memory frequency overwrite protection is activated.	1. Turn off memory overwrite protection (page 72)
Memory frequency cannot be changed.	1. Memory channel is protected.	1. Turn off memory access protection (page 73)
No transmission or low output power	1. Microphone or telegraph key is disconnected or poorly connected. 2. Antenna connection is poor or wrong. 3. Antenna matching is improper. 4. Microphone output level is low. 5. Transmission is inhibited ([PTT] key is locked.) 6. Transmission is made outside the amateur band. [OFF] is displayed. 7. Power supply is insufficient in capacity.	1. Connect microphone or key correctly. (page 14, 20) 2. Check antenna connection. (page 13) 3. Correct antenna matching. Connect correct antenna for operating bands. 4. Increase microphone gain. (page 85) 5. Unlock [PTT] key in Set mode. (page 82) 6. Select correct frequency in an amateur band. (page 94) 7. Use a regulated 13.8 V DC power supply with a capacity of 30 Amps continuous duty. The cable for the power supply should be kept as short as possible, and away from co-ax if possible.
Reception and transmission are normal, but communication is impossible.	1. SPLIT function is on. 2. RIT/TXIT function is on. 3. (For CW) Carrier is being received on the wrong side.	1. Turn this function off. (page 45) 2. Turn this function off. (page 65) 3. Tune in the correct frequency. (page 43)
Linear amplifier does not activate.	1. ALC is set to wrong level. 2. Connection between DX-SR8 and the Linear-amplifier is poor.	1. Adjust ALC level on your Linear-amp. 2. Check that relay-cable, ALC-cable, co-ax cable are all connected properly between DX-SR8 and the Linear-amp. Read the instruction of the amplifier.

\* About RF feed back in front control unit separation setting:

When the front control unit is separated and EDS-17 cable is used, depending on the condition of installation, operating power and frequency, you may encounter an event that your voice or keying tone may be heard from the speaker, or more evidently, from the headset while transmitting. Although DX-SR8 and EDS-17's separation cable have been designed to effectively eliminate such RF feed back, you may still experience this phenomena in some cases. To eliminate or minimize the feedback:

- \* Reel the excessive amount of the cable and bind it up in the way that the cable won't make an "antenna" for unwanted RF signal.
- \* Change the position of provided ferrite beads, add more beads or use a ferrite core to make a common-mode filter on the EDS-17 cable.
- \* Ground the DX-SR8 properly.
- \* Reduce output power.

A firmware update may be available from our web site at [alinco.com](http://alinco.com), and it may alter the function of the product after the update is performed. Please refer to the information given on the same site for details. It is recommended that you tell the version of firmware in case of contacting us or your dealer for technical assistance of this product if such update is performed.

# Appendix

---

## Options

Following accessories are available at your ALINCO dealer.

- EDX-2 automatic Long-wire antenna tuner

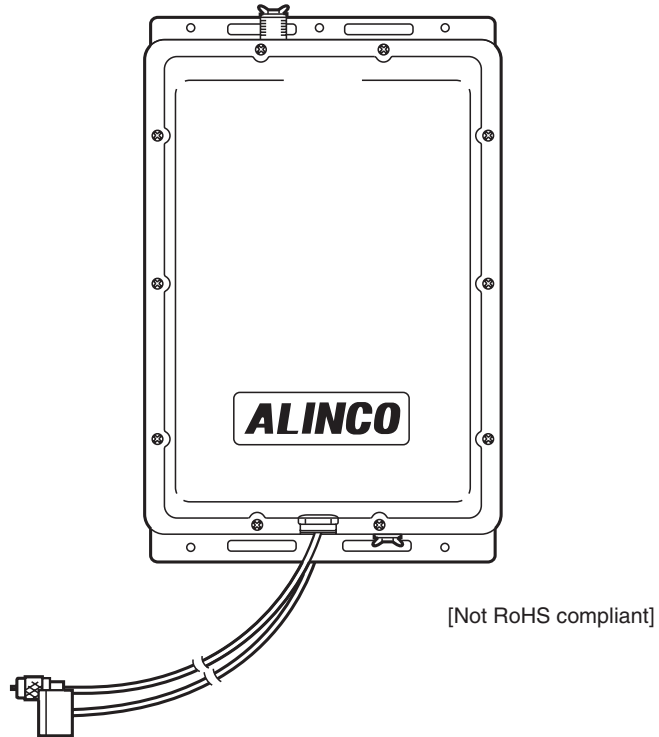

- EDS-17 Front control remote kit (Comes with 5 m Cable, front-panel bracket, unit-cover and hardwares)
- Regulated DC power supply
  - DM-330 MV series
  - DM-340 MV series

**IMPORTANT:** Please be advised that some of the accessories listed above are not RoHS compliant at the moment this manual has been edited, and they are intended for the sales to where RoHS order is not effective. Please consult with your local dealer for any updates about RoHS compliance of our products before purchase. Use of external power source cables are at your own risk per IEC/EN60950-1.

## About Mounting Bracket and Carrying Handle

**CAUTION:** Use only specified screws otherwise may cause damages to the components inside and voids warranty.

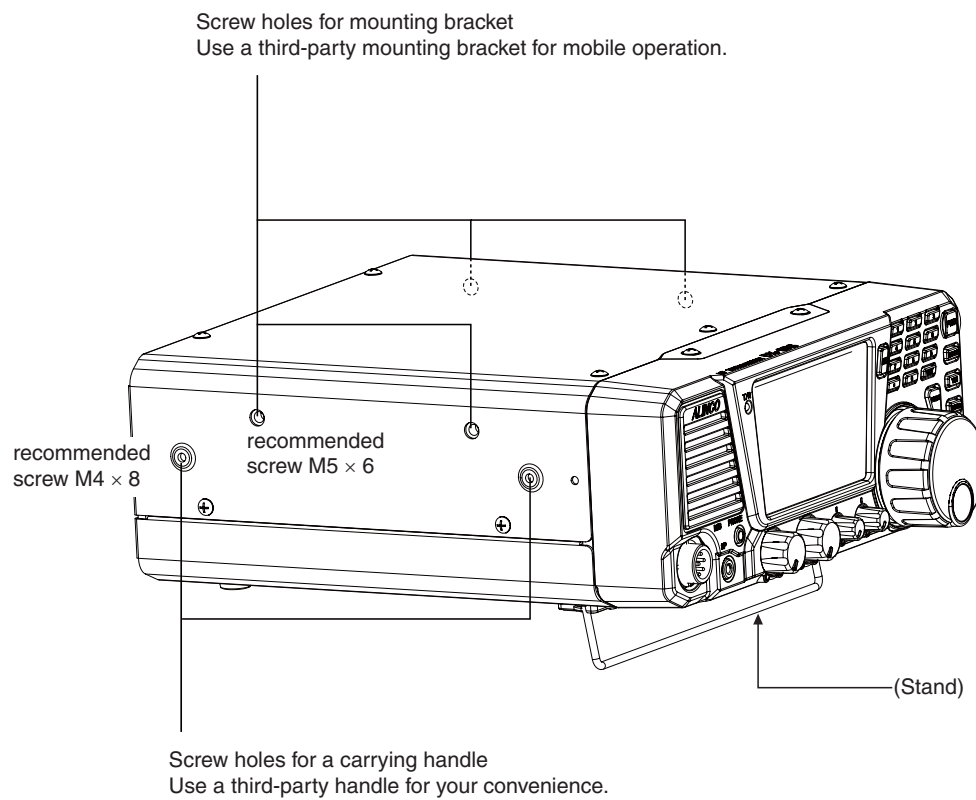

## External Antenna Tuner (Optional)

### ALINCO EDX-2

- Connection Example

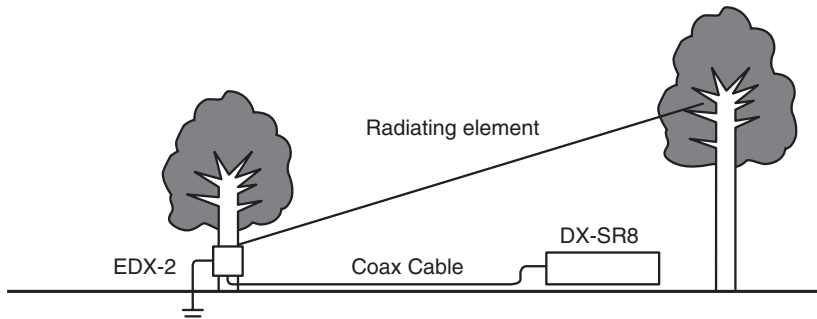

\* Although EDX-2 has been designed to be water-proof, it is strongly suggested to shelter from rain and/or direct sunlight.

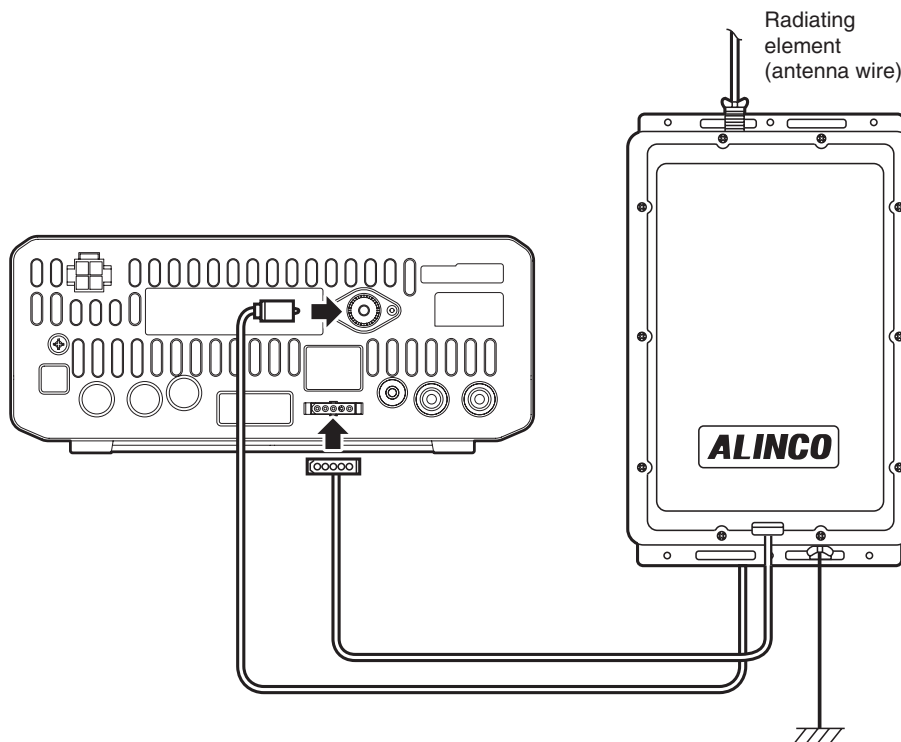

**CAUTION:** EDX-2's output terminal can be connected to long-wire or grounded vertical antennas only. Never connect it to antennas fed by coax-cable. Please be sure to read the instruction manual of EDX-2 for more important details and information.

## Specifications

<b>General</b>		<b>DX-SR8 ALL MODELS</b>
Operating mode		J3E (USB, LSB), A3E (AM), A1A (CW), F3E (FM)
Number of memory channels		600 channels simplex
Antenna impedance		50 $\Omega$ unbalanced
Frequency stability		$\pm$ 1ppm
Power requirement		13.8 V DC $\pm$ 15 % (11.7 to 15.8 V)
Ground method		Negative ground
Current drain	Receive	1.0 A (max.) 0.7 A (Squelched)
	Transmit	20 A
Operating temperature		-10 $^{\circ}$ C to 60 $^{\circ}$ C (+14 $^{\circ}$ F to +140 $^{\circ}$ F)
Dimensions		240 (w) $\times$ 94 (h) $\times$ 255 (d) mm (Projections not included) (9.45" (w) $\times$ 3.7" (h) $\times$ 10" (d)) 240 (w) $\times$ 100 (h) $\times$ 293 (d) mm (9.45" (w) $\times$ 3.94" (h) $\times$ 11.54" (d))
Weight		Approx. 4.1 kg (9 pounds)
<b>Transmitter</b>		
Power output	SSB, CW, FM	100 W (Hi) Approx. 10 W (LOW) Approx. 1 W (S-LOW)
	AM	40 W (Hi) Approx. 4 W (LOW) Approx. 0.4 W (S-LOW)
Modulation system	SSB	Balanced modulation
	AM	Low power modulation
	FM	Reactance modulation
Spurious emissions		Less than -50 dB (Less than -45 dB in 30 m band)
Carrier suppression		More than 40 dB
Unwanted sideband		More than 50 dB (1 kHz)
Maximum FM deviation		$\pm$ 2.5 kHz
<b>Receiver</b>		
Receiver type		Double conversion superheterodyne
Sensitivity	SSB	(0.15 to 1.8 MHz) 0 dBu (1 $\mu$ V)
	CW	(1.8 to 30 MHz) -12 dBu (0.25 $\mu$ V)
	AM	(0.15 to 1.8 MHz) +20 dBu (10 $\mu$ V)
		(1.8 to 30 MHz) +6 dBu (2 $\mu$ V)
FM	(28 to 30 MHz) -6 dBu (0.5 $\mu$ V)	
Intermediate frequency		1 <sup>st</sup> 71.75 MHz 2 <sup>nd</sup> 455 kHz
Selectivity	SSB, CW, AM (narrow)	2.4 kHz/-6 dB 4.5 kHz/-60 dB
	AM, FM	6 kHz/-6 dB 18 kHz/-60 dB
Spurious and image rejection ratio		More than 70 dB
Audio output power		More than 2.0 W (8 $\Omega$ , 10 %THD)
RIT variable range		$\pm$ 1.2 kHz
<b>DX-SR8</b>		
Microphone impedance		2 k $\Omega$
Transmit Frequency coverage		1.6 MHz - 29.99999 MHz
Receiver Frequency coverage		30 kHz - 34.99999 MHz

		<b>DX-SR8T</b>	<b>DX-SR8E</b>
Microphone impedance		300 $\Omega$	
Transmit Frequency coverage	160m band (1.8 M)	1.80000 - 1.99999 MHz	1.80000 - 1.99999 MHz
	80m band (3.5 M)	3.50000 - 3.99999 MHz	3.40000 - 3.99999 MHz
	* 60m band (5.3 M)	5.33050 MHz 5.34650 MHz 5.36650 MHz 5.37150 MHz 5.40350 MHz	-
	40 m band (7 M)	7.00000 - 7.29999 MHz	6.90000 - 7.49999 MHz
	30 m band (10 M)	10.10000 - 10.14999 MHz	9.90000 - 10.49999 MHz
	20 m band (14 M)	14.00000 - 14.34999 MHz	13.90000 - 14.49999 MHz
	17 m band (18 M)	18.06800 - 18.16799 MHz	17.90000 - 18.49999 MHz
	15 m band (21 M)	21.00000 - 21.44999 MHz	20.90000 - 21.49999 MHz
	12 m band (24 M)	24.89000 - 24.98999 MHz	24.40000 - 25.09999 MHz
	10 m band (28 M)	28.00000 - 29.69999 MHz	28.00000 - 29.99999 MHz
Receiver Frequency coverage		135 kHz - 29.99999 MHz	135kHz - 29.99999 MHz

\* TX output power of 60 m band is limited to 50 W. (High; LOW 10 W, S-LOW 1 W)

NOTE: All specifications are subject to change without notice ore obligation.



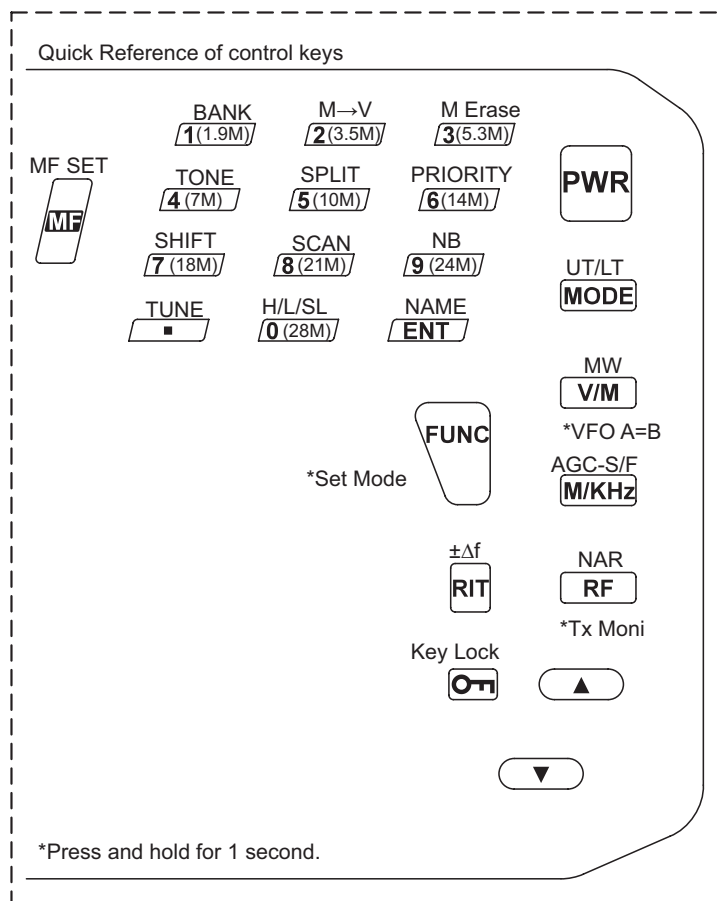

Quick references of keys and parameters setting mode.

\* You may make copies of this page, cut the charts and carry them with the unit for your references.

### Parameter Setting Mode

Menu	Default display	Function
00	SSB-0.1	Frequency Step of the ▲/▼ Keys Setting
	AM-1.0	
	FM-2.5	
01	PROT-OFF	Memory Overwrite Protection
02	ACCS-ON	Memory Frequency Access Protection
03	SC- 2S	Timer SCAN Setting
04	B-SCAN	Select Scan types
05	SSC-50	Search range setting for Search scan
06	SKIP	Memory scan skip Setting
07	DIMR-32	Dimmer
08	BEEP-ON	Beep Sound
09	U/L-ON	Automatic USB / LSB Selection
10	AGC-ON	Automatic AGC-S / AGC-F Selection
11	TXIT-ON	TXIT Function Setting
12	EKEY-ON	Electronic Keyer Setting
13	WPM-20	Electronic Keyer Speed Setting
14	PADDL-N	Electronic Keyer Reverse Setting
15	ST-800	Sidetone (CW Offset) Setting
16	BKIN-AT	Break-in Delay Time for CW operation
17	RAT-3.0	Key ratio
18	T-88.5	CTCSS Tone Encoding Setting
19	SPH-OFF	Speech Compressor
20	PTT.L-OFF	PTT Key Lock
21	APO-OFF	APO-Auto Power OFF
22	UD-RPT	UP/DOWN keys function setting
23	FUNC-MN	FUNC key resume timing setting