

Operating and Installation Manual

Barrett 4050 HF SDR Transceiver



BCM40500/13

s/w v1.7.0 and above

© Barrett Communications

Compliance

Barrett 4000 series transceivers comply to the following communications standards for equipment in the land mobile service utilising single sideband suppressed carrier emission:

- Australian New Zealand Standard: AS/NZS 4770:2000
- Federal Communications Commission Standard (FCC) Part 87 and Part 90. FCC ID: OW4-4050HF
- National Telecommunications and Information Administration (NTIA)
- Industry Canada (IC) RSS-125 Issue 2
- Joint Interoperability Test Command (JITC)

Barrett 4000 series transceivers comply to the following EMC and electrical safety standards:

- EN301 489-1 V 1.4.1 (2002-08).
- EN60950-1:2002.

FCC RF Exposure Compliance Statement

The Barrett 4000 Series transceivers have been evaluated and comply with the Federal Communications Commission (FCC) RF exposure limits for the General Population/Uncontrolled exposure environment.

In addition, the transceivers comply with the following standards and guidelines:

- FCC 96-326, Guidelines for Evaluating the Environmental Effects of Radio-Frequency Radiation
- FCC OET Bulletin 65 Edition 01-01 (2001) Supplement C, Evaluating Compliance with FCC
- Guidelines for Human Exposure to Radio Frequency Electromagnetic Fields
- ANSI/IEEE C95.1-1992, IEEE Standard for Safety Levels with Respect to Human Exposure to Radio Frequency Electromagnetic Fields, 3 kHz to 300 GHz
- ANSI/IEEE C95.3-1992, IEEE Recommended Practice for the Measurement of Potentially Hazardous Electromagnetic Fields - RF and Microwave.

RF Exposure Warning

To ensure optimal transceiver performance and to avoid exposure to excessive electromagnetic fields, the antenna system must be installed according to the instructions provided.

High voltages exist on the antenna during transmission and tuning. Do not touch the antenna during these activities. RF burns may result.

Install the grounding system or counterpoise as directed to prevent RF burns from any metal part of the transceiver.

Safe working distance is based on continuous exposure to CW type transmissions, as set out in the ICNIRP Exposure Guidelines (1998) for occupational exposure. Safe working distance can be reduced with normal voice communication.

For IC and FCC compliance, when the 4050 transceiver is used at a power level of 150 watts PEP and a 13 dBi gain antenna, the antenna(s) used with this Transceiver should be located at least 6 metres from the operator and should not be co-located or operating in conjunction with any other antenna or transmitter.

For IC and FCC compliance, when the 4050 transceiver is used in a vehicular environment at a power level of 150 watts PEP with 1.5 dBi gain antenna, the antenna(s) used with this transceiver should be located at least 1.6 metres from the operator and should not be co-located or operating in conjunction with any other antenna or transmitter.

Typical antenna types and minimum separation distance:

Antenna type	Gain (dBi)	PEP (W)	Minimum safe separation distance (m)	Typical Environment
Automatic tuned and whip	0	150	1.3	Vehicle
Magnetic Loop	1.5	150	1.6	Vehicle
Multi-wire Broadband	5	150	2.4	Fixed
Log-Periodic	13	150	5.9	Fixed
Automatic tuned and Whip	0	100	1.0	Vehicle
Magnetic Loop	1.5	100	1.2	Vehicle
Multi-wire Broadband	5	100	1.8	Fixed
Log-periodic	13	100	4.4	Fixed
Automatic tuned and Whip	0	30	0.5	Vehicle

Antenna type	Gain (dBi)	PEP (W)	Minimum safe separation distance (m)	Typical Environment
Magnetic Loop	1.5	30	0.7	Vehicle
Multi-Wire Broadband	5	30	1.1	Fixed
Log-Period	13	30	2.7	Fixed

The above antennas are identified for reference only. It is important that the installer and operator maintain a minimum safe separation distance with the actual antenna used in the installation and to insure, in a vehicular environment, that the transmitter is only used when persons outside the vehicle are at least the recommended lateral distance away.

The image below shows an example of minimum recommended separation distance from antenna in a vehicular environment.

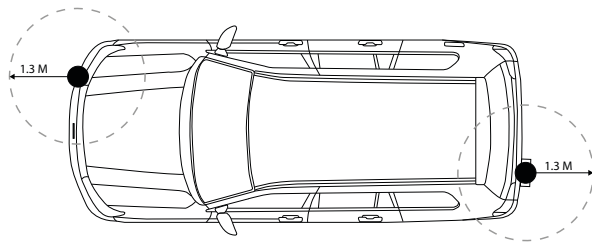

● 2019 Automatic Tuning Mobile HF Antenna

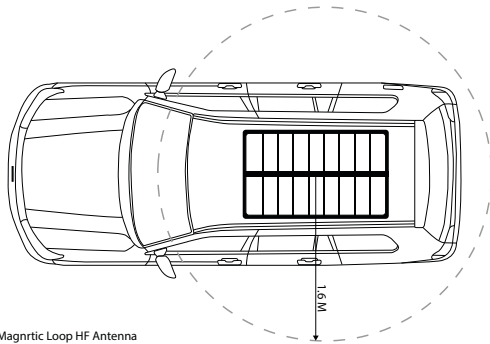

■ 2018 Mobile Magnrtic Loop HF Antenna

Note: References to Vehicular environments and minimum safe operating distances relate to persons outside the vehicle only and not to persons within the vehicle.

Contents

INTRODUCTION 1	1
Introduction	2
Important Disclosure.....	3
Terms & Abbreviations	4
The Barrett 4050 HF Transceiver	6
Transceiver Front	6
Transceiver Rear - ip	7
Transceiver Rear - se.....	8
Starting the Transceiver.....	9
Keypad	9
Display	10
Swipe Menu	11
BASIC OPERATION 2	14
Basic Configuration Diagram.....	15
Antenna Type	16
Selecting a Channel.....	17
Making a Voice Call.....	18
Making an Emergency Call	19
Receiving an Emergency Call	20
SELCALL 3	21
Overview	22
Important Selective Calling Information	23
Summary of Calling Systems	24
Setting up a Self ID	25

Setting up Contacts.....	26
Additional Contact Information	28
Making a Selcall	29
Beacon Call	30
Selcall.....	31
Telcall.....	32
Advanced Call History	35
Advanced Selcall Functions	40
Selcall Settings.....	40
Pagecall.....	41
GPS Request.....	42
GPS Position.....	44
Status Call.....	45
Secure Call	46
Hang-up Call	47
Selcall Networks.....	48
BASIC SETTINGS 4.....	51
System Information.....	52
Head Device ID.....	52
Serial Number	52
Version Information	52
Transceiver Options.....	53
Configuration Pack Information	53
SDV/4026 Serial Number.....	53
General Settings.....	54
Audio Settings.....	55
Display Settings.....	56

PROGRAMMING 5	57
Channel Programming	58
Programming Channels Through the Front Panel.....	58
Free Scroll Rx/Tx.....	62
Programming Via USB	64
ADVANCED OPERATION 6	67
ARINC Call	68
Audio - Advanced.....	69
Rx Configuration	69
Tx Configuration	69
Audio Bandwidth	69
Line Audio.....	70
Line Encoding	70
Line Out Level	70
Line In Level	70
Audio Record	70
Custom Filter Bandwidth	70
Dynamic Microphone Preamp	70
Collective Call	71
Digital Voice (Encoding)	72
Export	73
Frequency Hopping	74
Selecting the Hopping Band.....	74
Entering the Hopping PIN	74
Frequency Hop Rate	74
Enabling and Disabling Hopping.....	74
GPS Push	75

GPS Push State.....	75
Privacy Key	75
IO Settings	76
RS232 Connection.....	76
RS232 Network Encryption	76
RS232 Out (async. Indications).....	76
RS232 Baud Rate.....	77
External Alarm Type	77
Antenna Select Behavior	77
Antenna 1	77
Antenna 2	77
Modes	79
Mute	80
Network	82
Noise Reduction (NR)	84
RF Settings	85
Rx Preamp.....	85
Tx Over Beep	85
Tx Timeout	85
Noise Blanker	86
Tx Power Level	86
AGC Hang	86
Broadcast Filter	86
Scanning	87
Scan Settings	88
Secure Display Mode	91
Security Settings.....	92
Use OEM Selcall Privacy Key	93

OEM Selcall Privacy Key.....	93
Frequency Hop PIN.....	93
Frequency Hop Rate.....	93
OEM Secure Type.....	93
OEM Secure Key.....	93
Secure Digital Voice/Data Key.....	94
Digital Voice Baud Rate.....	94
Selcall Secure Call Hop Rate.....	94
Selcall Secure Call Code.....	94
SDV/4026 Programming Mode.....	94
Service Mode.....	94
Enable Power On PIN.....	95
Transceiver Lock.....	95
Over the Air Zeroise (OTAZ).....	95
Zeroise.....	95
Remote Access Password.....	95
Stealth Mode.....	96
Theme Schedule.....	97
Tuning.....	98
INSTALLATION 7.....	99
Introduction.....	100
Base Station Installations.....	101
Site Selection Recommendations.....	101
Cooling Fan.....	105
Installing the Cooling Fan.....	105
Antennas.....	106
912 Broadband Dipoles.....	106

4017 Automatic Tuning Horizontal Dipole Antenna.....	108
4011 Automatic Antenna Tuner for Base Station Installations	111
Post-Installation Performance Test.....	113
911 Automatic Antenna Tuner for Base Station Installations	116
Post-Installation Performance Test.....	117
Mobile Installations.....	121
Mobile Pack	121
2019 Automatic Tuning Mobile HF Antenna	128
2018 Mobile Magnetic Loop Antenna.....	139
Marine Installations.....	141
Installing a Secondary Control Head.....	146
Installing Dual Antennas	147
APPENDICES 8.....	149
Appendix 1 - Specifications	150
Appendix 2 - Connectors.....	153
Appendix 3 - Overview of HF Operation	158
Appendix 4 - BITE Test	162
Warranty Statement.....	165
Contact Details.....	166
Index.....	167

INTRODUCTION 1

This chapter contains the following sections:

- Introduction
- The Barrett 4050 HF Transceiver
- Activating the Transceiver
- Display

Introduction

The Barrett 4050 Transceiver is an SDR based HF SSB transceiver with a frequency range of 1.6 to 30 MHz in transmit and 250kHz -30MHz in receive. The Barrett 4050 is designed using the latest technology enabling a physically small package with a full feature complement.

Designed to operate in the most arduous environments, as encountered in off-road vehicles, vessels and aircraft, the Barrett 4050 will provide many years of efficient and trouble free service.

The Barrett 4050 supports features such as Selective Call (Selcall), direct dial telephone connection to base stations fitted with telephone interconnect systems (Telcall), GPS location, 2G and 3G ALE (Automatic Link Establishment), frequency hopping, digital voice, data transmission and remote diagnostics. These features make the Barrett 4050 HF Transceiver one of the most economical and versatile HF transceivers available today.

The Barrett 4050 Transceiver caters for increased use of HF data transmission for Internet email access and point-to-point data applications, by providing a comprehensive data modem interface port, high speed transmit-to-receive switching, a high stability frequency standard and an efficient cooling system option.

The Barrett 4050 Transceiver can be operated in either a local (desktop) configuration for base station applications or, with the addition of an inexpensive mobile pack, in a remote control (trunk mount) configuration for mobile applications.

The Barrett 4050 Transceiver can be controlled from all major mobile and desktop platforms. Full remote control is available via the Barrett 4050 Remote Control app, providing unprecedented access to all transceiver functionality across all major platforms.

Operated from 12 V DC to 24 V DC power supplies, the transmitter is rated at 125-150 watt PEP in voice mode and is protected from over-voltage or reverse-voltage application.

Up to 1000 channels (depending on the 4050 variant) are available. Auxiliary features such as Selcall, Telcall, scanning, mute status, alarm system etc. can be individually enabled or disabled for every channel as required to suit your operation.

Teamed with other complementary Barrett products which include antennas, power supplies, vehicle tracking packages and HF modems, the Barrett 4050 HF Transceiver becomes a powerful tool, providing solutions to many long distance communication requirements.

Please refer to the 4000 Series IP Connectivity/Networking Guide (P/N BCM40507) for information regarding IP connectivity and networking of the 4050 Transceiver.

Important Disclosure

Please note that this manual describes all the features of the 4050 HF SDR Transceiver and that some variants of the 4050 may not have all the features installed.

Illustrations may show accessories, optional equipment or other features which are not part of the standard specification and are not available in some countries.

Terms & Abbreviations

Term / Abbreviation	Definition
ALE	Automatic Link Establishment
AM	Amplitude Modulation
ARINC	A set of standards as established by Aeronautical Radio, Incorporated (ARINC).
CCIR	One of many possible Selcall formats as defined by the Consultative Committee on International Radio (CCIR).
CF	Custom Filter selection
CW	Continuous Wave (used for Morse code)
dB	Decibels
dBm	Power ratio in decibels (dB) of the measured power referenced to one milliwatt (mW).
DSP	Digital Signal Processing
ESU	Encryption Synchronisation Unit
FHSS	Frequency Hopping Spread Spectrum
GPS	Global Positioning System
HF	High Frequency
INT	International Selcall format
ISB	Independant Sideband
LSB	Lower Sideband
LUF	Lowest Usable Frequency
MUF	Maximum Usable Frequency
OEM	Original Equipment Manufacturer, OEM Selcall Format
OTG	On-The-Go (USB)
PCB	Printed Circuit Board
PEP	Peak Envelope Power
PIN	Personal Identification Number
PSTN	Public Switched Telephone Network
PTT	Push to talk

Term / Abbreviation	Definition
Receive Only Channel	A channel that receives only and cannot be transmitted on.
Revertive Tone / Signal	An acknowledgment signal automatically transmitted from a station receiving a Selcall.
RF	Radio Frequency
RFDS	Royal Flying Doctor Service
Scan Table	A list of channels used when scanning for incoming calls.
Selcall	Selective Calls
SCF	Suppressed Carrier Frequency
SSL	Signal Strength Level
Station ID	The ID of the station being called (the receiving station's Self ID).
Self ID	The programmed address identification number of a local station. (Used by other stations to call you.)
SMS	Short Message Service
SSB	Single Sideband (a transmission format)
Telcall	Telephone call using the Selective Call protocol.
USB	Upper Sideband
VSWR	Voltage Standing Wave Ratio

The Barrett 4050 HF Transceiver

Transceiver Front

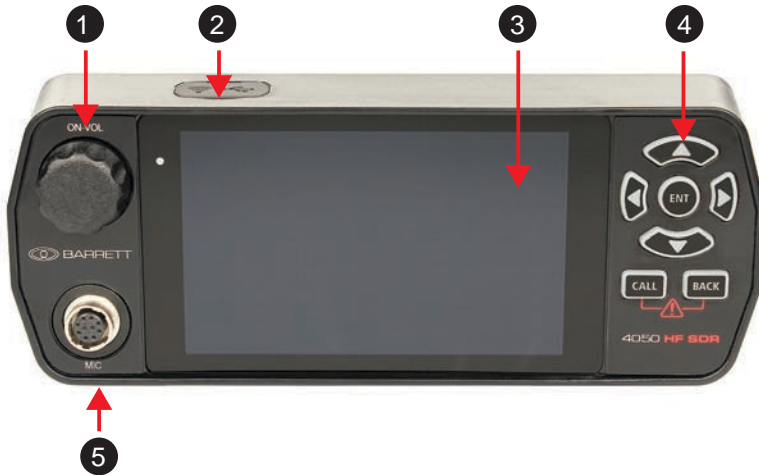

- 1 Power button which combines switching the transceiver on and off with adjusting the volume.
This will be represented as  throughout the manual
- 2 USB / WiFi Socket
- 3 Touchscreen
- 4 Keypad
- 5 Microphone socket

Transceiver Rear - ip

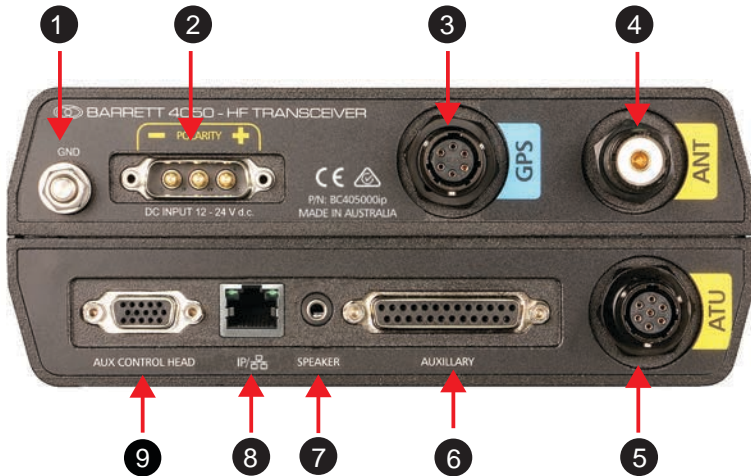

- | | | |
|----------|--------------------------|---|
| 1 | GND | Use this stud to attach to a ground (earth) connection. For example, a vehicle chassis |
| 2 | DC INPUT
12 - 24 V DC | Power input for use with the 4022 power supply |
| 3 | GPS | Input for GPS receiver (P/N BCA40009) for vehicle tracking / location applications |
| 4 | ANT | Antenna socket |
| 5 | ATU | Interface for Barrett automatic tuning antennas and 4075 Linear Amplifier system |
| 6 | AUXILIARY | 25-way auxiliary interface |
| 7 | SPEAKER | Output for loudspeaker (P/N BCA40015) |
| 8 | IP | RJ45 Ethernet port for IP connection. |
| 9 | AUX CONTROL
HEAD | This can be used to attach a secondary control head (via a six metre cable) in addition to the front panel. |

Transceiver Rear - se

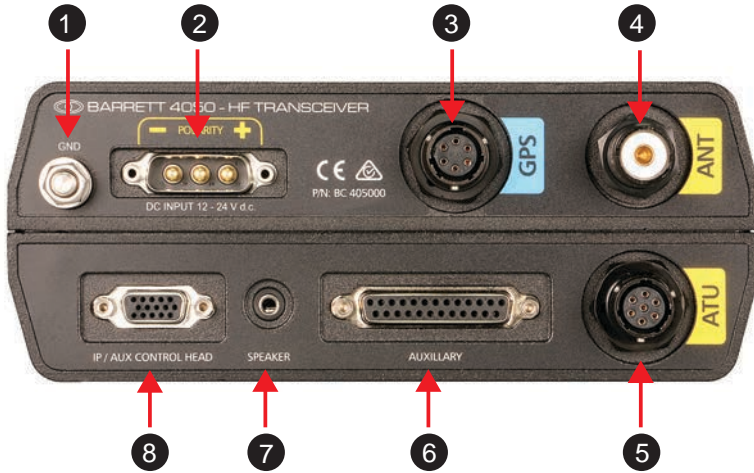

- | | | |
|---|--------------------------|--|
| 1 | GND | Use this stud to attach to a ground (earth) connection. For example, a vehicle chassis |
| 2 | DC INPUT
12 - 24 V DC | Power input for use with the 4022 power supply |
| 3 | GPS | Input for GPS receiver (P/N BCA40009) for vehicle tracking / location applications |
| 4 | ANT | Antenna socket |
| 5 | ATU | Interface for Barrett automatic tuning antennas and 4075 Linear Amplifier system |
| 6 | AUXILIARY | 25-way auxiliary interface |
| 7 | SPEAKER | Output for loudspeaker (P/N BCA40015) |
| 8 | IP/AUX CON-
TROL HEAD | This can be used to attach a secondary control head (via a six metre cable) in addition to the front panel. This can also be used to attach a linear system or connect to an IP network. |

Starting the Transceiver

Ensure the transceiver is attached to a power source appropriate for your situation. Please refer to the Basic Operation section on page 14.

To turn the transceiver on, momentarily press the on button: .



Pressing the same button will:

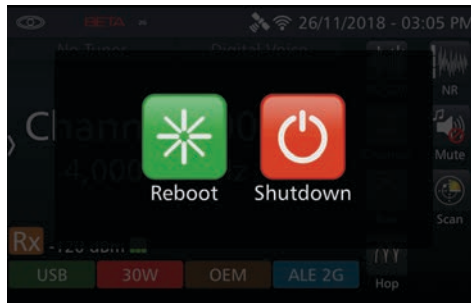

- Press for three seconds powers down the transceiver.
- Holding down for 10 seconds at any time will perform a hard shut down of the transceiver.
- Pressing briefly brings up the Power Button Menu allowing the transceiver to be rebooted or shut down.





Keypad

There are seven keys on the keypad. Some keys have multiple functions assigned to them depending on when or how long the key is pressed.

Key	Function
	Channel Up / Scroll up
	Channel Down / Scroll down
	Scroll left and right

Key	Function
	Enter / Set a menu item
	Make a call
	Clear / Back one step

Press the  and  buttons together to initiate an emergency call. See page 19 for further information.

Display

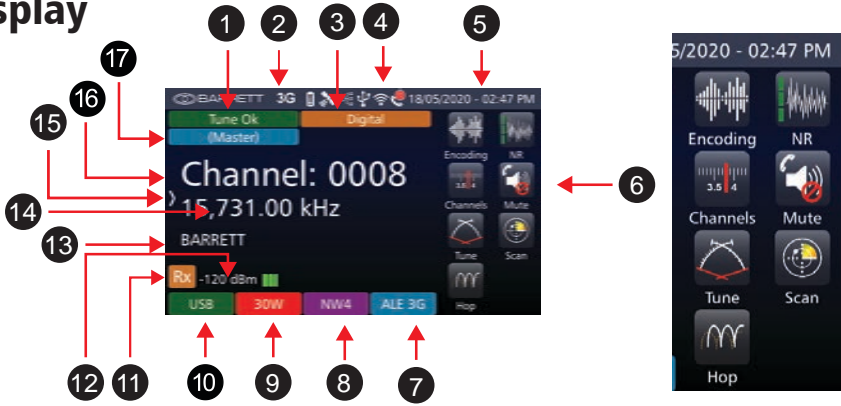

1	Tune Status	5	Date and Time
2	ALE Status (2G/3G)	6	Operation Icons
3	Encoding Status	7	ALE (Channel) Status
4	Status Indicators	8	Selcall Network
	Access Point	9	Transmit Power
	WiFi Client	10	Modulation Mode
	Low Voltage	11	Receive/transmit status
	Screen Lock	12	Receive Strength/Transmit Power Indicator
	Busy	13	Channel Label
	GPS	14	Channel Frequency
	USB Storage	15	Swipe Menu Access
	Missed Call	16	Channel Number
	BoB Active	17	ALE 3G Sync status
	Ethernet		
	Networked RS232		

A number on the WiFi Client icon or the Networked RS232 icon indicates the number of connections being made to that device.

Operation Icons



Allows selection of voice encoding type and toggles voice encoding on or off.



Cycles through low, med, high or no noise reduction.



Opens the channel select menu.



Toggles mute on/off. See page 80 for further mute details.



Manually tunes the antenna.



Enables/disables scanning.



Enables/disables Frequency Hopping (see page 74).

Swipe Menu

To access this menu, either swipe horizontally across the screen from the left edge to drag open the swipe menu or press and hold the right arrow key.

Accessing the Swipe Menu



Swipe Menu

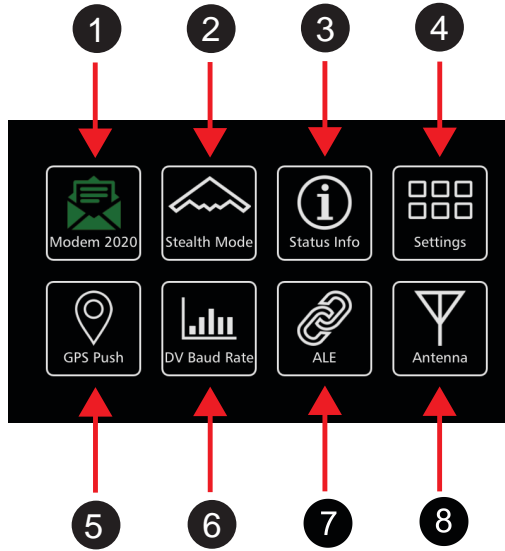

- 1 Modem Select - Tap to toggle through available internal modem options for data use.
- 2 Stealth Mode - When active, all lights and sounds are disabled.
- 3 Status Information - Displays IDs and other information.
- 4 Settings Menu - Access to Settings menus.
- 5 Enable/Disable GPS Push (if fitted) or Display Settings.
- 6 DV Baud Rate - Quick access to Digital Voice Baud Rate settings.
- 7 ALE Menu - Quick access to ALE menu.
- 8 Antenna Select - Quick access to antenna select menu.

The items displayed in the Swipe menu are determined by the options installed in the transceiver. Each of the Modem, Stealth Mode and GPS Push icons will turn green when active.

BASIC OPERATION 2

This chapter contains the following sections:

- Basic Configuration Diagram
- Antenna Type
- Channel Selection
- Making a Voice Call
- Making an Emergency Call

Basic Configuration Diagram

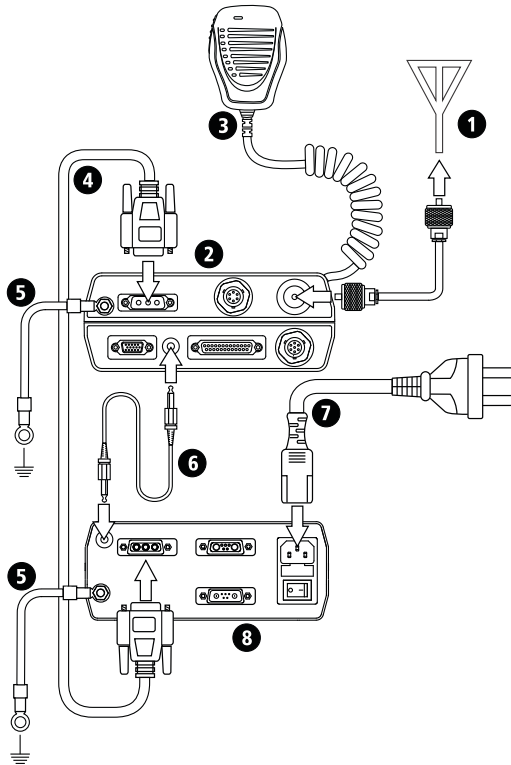

- 1 Antenna
- 2 Barrett 4050 HF SDR Transceiver (P/N BC40500)
- 3 DC Power Cable and Connector (P/N BCA40006)
- 4 Power cable 4022 to 4050 (P/N SA-42020)
- 5 Ground
- 6 Speaker cable (P/N SA-45010)
- 7 IEC Mains cord (P/N SA-00020)
- 8 Barrett 4022 24V Power Supply (BC402200)

Antenna Type

Before making a call, an antenna type needs to be selected from Settings < IO.

This menu sets the antenna type or linear amplifier used with the transceiver.

Tap **Antenna 1 Type** from the IO screen to display the Antenna 1 Type screen.

The Antenna Select menu can also be accessed from the Swipe screen.

To reveal more items, either swipe down on the touch screen or press



Select an antenna type from the following:

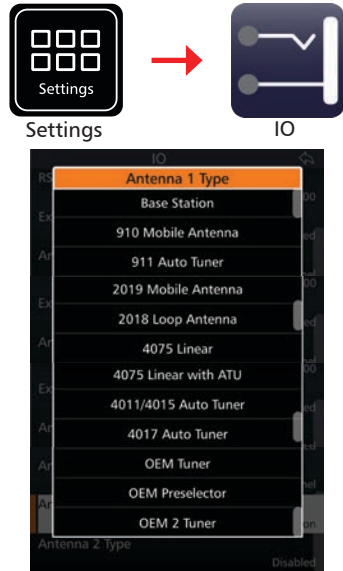

Antenna Type	Select when...
Base Station	Base station antennas such as the Barrett 912 series are used. No tuning signals are emitted on channel change.
910 Mobile Ant	Using a Barrett 910 automatic tuning mobile antenna
911 Auto Tuner	Using a Barrett 911 automatic tuner
2019 Mobile Ant	Using a Barrett 2019 automatic tuning mobile HF antenna
2018 Loop Ant	Using the 2018 Mobile magnetic loop HF antenna
4075 Linear	Using the transceiver with a Barrett 4075 series linear amplifier.
4075 Linear with ATU	Using the transceiver with a Barrett 4075 series linear amplifier with ATU.
4011/4015 Auto Tuner	Using a Barrett 4011 automatic tuner
4017 Auto Tuner	Using a Barrett 4017 automatic tuner
OEM Tuner	3040 tuner compatible (non-Barrett product)*
OEM Preselector	Using a non-Barrett Preselector
OEM 2 Tuner	F2265 tuner compatible (non-Barrett product)* ^

*For further information, please contact Barrett Communications.

^ Requires extra hardware. Please contact Barrett Communications.

Selecting a Channel

There are two ways to select a channel on the Barrett 4050 HF SDR Transceiver.

1. From the home screen, press the up (A) or down (B) keys on the keypad. This will allow a user to cycle through the programmed channels.
2. From the transceiver home screen, press the channels button. This brings up the Select Channel menu and shows all of the channels programmed into the transceiver in one place. Tap a channel to select it.

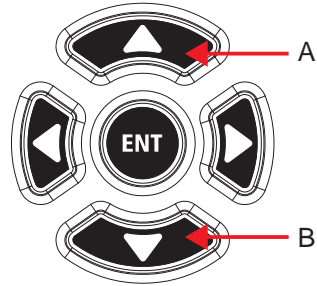

Channels

Holding down this channel button opens the Channel information screen of the currently selected channel. This allows the operator to edit channel settings. Pre-programmed channels and ALE enabled channels cannot be modified.

If there are no channels programmed into the transceiver, turn to page 58 for instructions on channel programming.

Alternately, to search for a specific channel, in the Channel Select menu tap  and type in the number of the channel as programmed in the transceiver eg. typing 4 will select channel 4.

Making a Voice Call

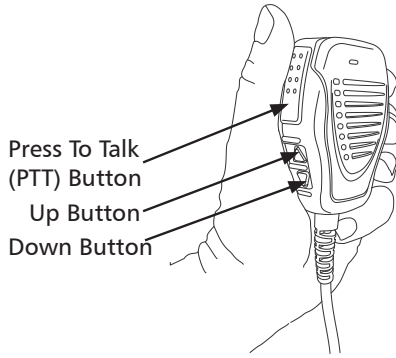

When Using the Microphone:

1. Press and hold the PTT (transmit) button only while talking
2. Position the microphone close to your mouth
3. Speak clearly
4. Use the word "over" to indicate that you have finished speaking, and then release the PTT (transmit) button.

Note:

- *The Barrett 4050 has a transmit time-out facility. This facility (when programmed) allows the transmitter to be keyed in transmit mode with the PTT (transmit) switch for a set time period, after which the transceiver switches to receive until the PTT (transmit button) is released and re-keyed. This facility prevents the transmitter transmitting for long periods of time if, for example, the microphone becomes jammed between seats in a vehicle causing the PTT (transmit) switch to be held down. Disabling or changing the time of the transmit timeout facility can be set either when programming the transceiver or in the RF Section of the Settings menu. See page 85.*
- *The microphone up / down buttons can be configured for channel change or volume control functions either when programming the transceiver or in the General Section of the Settings menu. See page 54.*

Making an Emergency Call

Note: the emergency call function must be enabled and emergency channels must be programmed via the Barrett 4000 Series HF SDR Programming Software (P/N BCA40001).

All Selcall emergency calls are transmitted by pressing the **CALL** and **BACK** buttons together for more than two seconds.



The action of the emergency call depends on how the transceiver has been programmed.

- Selective Call alarm that transmits and automatically changes to a selection of channels. If a GPS receiver is fitted and enabled, the GPS position is also sent with the call.

Note: After the emergency call has been sent, there is no indication that a call has been sent for security purposes and the radio resumes scanning of the currently selected scan table, ALE 2G preset map or the ALE 3G pool entries depending on the configuration..

Important: To receive a callback after issuing the emergency call it is necessary to add at least one of the emergency channels to the scan table, ALE 2G preset map or ALE 3G pool entries.

Royal Flying Doctor Service (RFDS) alarm (AUSTRALIA ONLY). Two-tone alarm 880 Hz + 1320 Hz continuous (Australian use only) – alerts the Royal Flying Doctor Service on RFDS channels.

1. Select a channel with RFDS as the Selcall format.
2. Simultaneously press and hold the **CALL** and **BACK** buttons

The RFDS alarm will continue transmitting for ten seconds even if you have released the **CALL** and **BACK** buttons.

To cancel the RFDS alarm, press the **PTT** button or the **BACK** button.

Receiving an Emergency Call

On receipt of an emergency Selcall, a distinctive audio alarm is emitted and the following message displayed.



If the transceiver sending the emergency Selcall is fitted with a GPS receiver, the position will also be displayed.



SELCALL 3

This chapter contains the following sections:

- Overview
- Important Selective Calling Information
- Summary of Calling Systems
- Setting up a Self ID
- Setting up Contacts
- Making a Selcall
- Advanced Selcall

Overview

This chapter covers all types of Selcall available on the Barrett 4050 Transceiver. All of these options are not available in all countries and may need to be purchased separately.

Selcall is a signalling system based on standard CCIR-493 for use on HF networks. It utilises a type of protocol where the transmission begins with a brief sequence of audio tones.

There are several different types of Selective Calling Systems available in addition to simple point-to-point HF communications.

The calling systems available for the transceiver are listed below:

- International (INT) - A four and six digit Selective Call system, fully interoperable with the UN format published in September 2004 and fully backwards compatible with all previous Barrett four and six digit Selcall protocols.
- OEM - A four and six digit Selective Call system compatible with other major HF manufacturers including those using encryption. Includes Selcall, Telcall, Beacon Call, Emergency call, Pagecall and GPS call.
- CCIR - A four digit Selective Call system as specified by CCIR-493.
- RFDS - Royal Flying Doctor Service (Australia Only)

Important Selective Calling Information

Selcall Self IDs

The 4050 transceiver can hold up to 14 different Selcall Self IDs assigned to it. These Selcall IDs can be any combination of four or six digit OEM or INT type ID.

Selcall Decode

The transceiver has the ability to decode both OEM and International Selcalls on any channel programmed as a Selcall channel. However, the call must be addressed to the relevant ID (OEM or INT).

Calls for each format type will only be decoded if there is at least one Self ID of that format programmed into the transceiver Self ID group.

Selcall Transmit

Selcall formats in transmit are channel specific. For example, only call types programmed for the channel are permitted. This means International format calls can only be sent on channels that are programmed as International Selcall channels. OEM calls can only be sent on channels that are programmed as OEM Selcall channels

Special Notes for the OEM Selective Call Protocol

- Six digit OEM 1 calls will only be decoded by other Barrett transceivers fitted with the OEM 1 Selcall protocol or other manufacturer's transceivers that use DES56 encryption. This does not require an export permit.
- Four digit OEM 1 calls will be decoded by Barrett 4050 transceivers using the International Selcall (four and six digit) and other manufacturer's transceivers with similar CCIR-493 based Selective Call systems.
- Four and six digit GPS and Status data calls use the OEM privacy key to encrypt the data. If this eight digit key has not been programmed by the programming software, a default privacy key of 99999999 is automatically used for transmission.
- Four and Six digit Page calls also use the privacy key but unlike the other calls, the user has the option to manually enable or disable the privacy key. When disabled, the data is sent as plain text.
- Emergency GPS calls are automatically sent as plain text (four and six digit).

Summary of Calling Systems

Call Type	International	OEM
Emergency Call	Yes	Yes
Beacon Call	Yes	Yes
Selcall	Yes	Yes
Telcall	Yes	Yes
ARINC Call	Yes	Yes
Page Call (SMS)	Yes	Yes
GPS Call (Data & Request)	Yes	Yes
Secure Call	Yes	No
Status Request Call	Yes	Yes

The three most commonly used calls are Beacon Call, Selcall and Telcall. The other calls are more advanced and can be found in the Advanced Selcall Functions section of this chapter on page 40.

Selective Call - Beacon Call

This call type allows the Operator to determine the signal quality between their station and the station they want to call on a particular channel, but without actually alerting the station they are doing so.

Selective Call - Selcall

This call type is used to hail another station or stations, the receiving station will alert the operator that a call has been received.

Selective Call - Telcall

This call type uses the Selective Call system to transport a telephone number from a station on a HF network to a base station equipped with a telephone interconnect unit to initiate phone calls onto the international telephone network.

Note: For Selcall and Telcall functions to operate, channels must be enabled for Selcall operation.

Setting up a Self ID

1. From the Settings menu, tap the Selcall icon.



2. Tap INT Selcall ID (4 digits). This will set up a 4 digit ID.



3. Type in a four digit number. This will either be provided to you by your network provider or an original ID may be able to be used if it does not conflict with another ID on the network.



The procedure is the same for the INT Selcall ID (6 digits), OEM Selcall ID (4 digits) and OEM Selcall ID (6 digits).

Note: Having both a four digit and the six digit ID is not required, either will still allow successful operation. It is recommended that the four digit or six digit INT and OEM IDs be the same for easy self identification.

A list of all of a transceiver's current IDs can be found under Selcall Networks in the Selcall menu.

This shows all the current Selcall IDs for a transceiver and the networks that they are attached to, see page 48.

Setting up Contacts

1. From the Settings menu, tap the Contacts icon.



2. To add a new contact tap the + button on the left of screen.

The following menu will open.

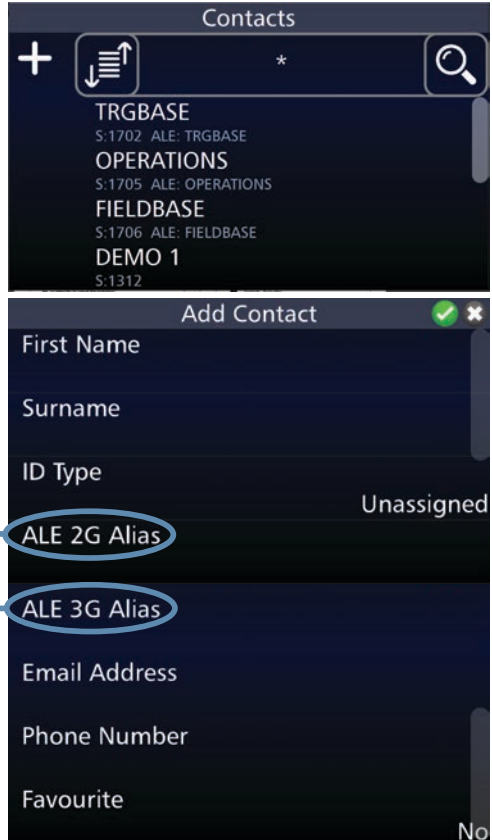

Will not be described in this manual. See ALE 2G and ALE 3G User Guide (P/N BCM40524)

From this menu, enter a name for this contact. Both first name and last name do not have to be completed.

ID type, refers to the type of ID the transceiver you are inputting has, whether it be 4 digit, 6 digit, ARINC or unassigned. Select which is appropriate and enter the Selcall ID.

An email address and phone number can also be entered. Once again, these do not have to be entered for basic functionality of the transceiver.

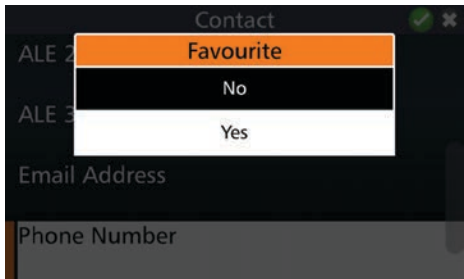
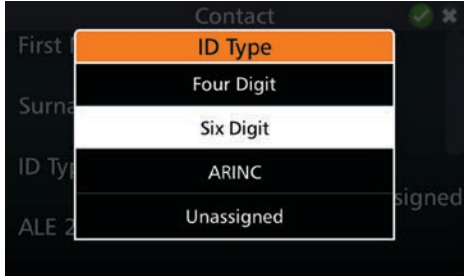

To favourite this contact, select yes under Favourite.



3. To save the contact, tap  in the top right hand corner of the screen and select yes.

Additional Contact Information

Searching Contacts

Either tap  or press  or  to display the results of the search.

The icon on the left of the search bar clears the search and the icon on the right cancels the search

The contacts list can be sorted by first name or by last name using the icon located to the left of the search field.

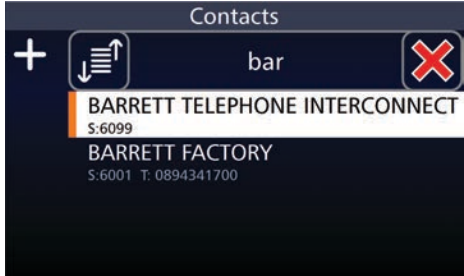

Editing Contacts

To edit contact details, select the desired contact by using the  and  keys and either tap the contact or press  from the keypad

The Edit Contact screen displays. Select and change the desired settings.

Deleting Contacts

From either the Settings<Contacts screen or the Call<Contacts screen, tap and hold a contact for two seconds to trigger the Delete Contact screen. To delete the contact, select Yes, or select No to cancel the operation.

Making a Selcall

Before making a Selcall, ensure the transceiver is not scanning channels and select a Selcall channel. For more information regarding channel selection and basic voice calls, see Chapter 2 - Basic Operation (page 14).

Use the **CALL** key to access the Manual Call screen.

From this menu, Selcalls, Contacts and Favourites can be accessed.



- 1 Call Type Selection Menu
- 2 Contacts
- 3 Contacts - Favourites
- 4 Call Sub-types
- 5 Call Key
- 6 Call Type



Beacon Call

Beacon Call allows the operator to determine the signal quality between their station and the station they want to call on a particular channel, but without actually alerting the station they are doing so.

When a Beacon Call is sent to another station, and if the channel being used is open, the remote station sends back a distinctive four-tone revertive signal. The operator can judge the quality of the channel for communications purposes by the strength and clarity of this distinctive tone. Using Beacon Calls on several available channels will determine which channel is best to use for subsequent Selcalls or Telcalls.

Note: both stations must be programmed for Selcall or Telcall operation.

Sending a Beacon Call

1. Listen for traffic on your selected channel. If traffic is heard, select another channel and try again.
2. Press  and, if necessary, press the  icon to show the Call Selection screen.
3. Either:
 - Select Beacon Call, enter a Selcall Id manually and press Enter, or
 - Choose a contact from the  Contacts icon and then select Beacon Call.
4. Wait for the Beacon Call to be sent and listen for the distinctive four-tone revertive signal from the station you have called.
 - If a revertive tone is not heard, or is difficult to hear, try another channel and repeat the process until the revertive tone is clear.

















Receiving a Beacon Call

When a transceiver receives a beacon request call, it responds by transmitting the Beacon Call revertive tones. No indications occur on the transceiver. Beacon Calls are not saved in the Selcall History.

Selcall

Sending a Selcall

1. Select the channel to send the Selcall on (Beacon Call can be used to determine the best channel)
2. Listen for traffic on that channel. If traffic is not heard, continue.
3. Press  and, if necessary, press the  icon to show the Call Selection screen.

Call Selection		
 Selcall	 ALE 3G	 ARINC
 Beacon	Selcall	 Telcall
 Pagecall	 GPS Req	 GPS Pos
 Hangup	 Status	 Secure
4. Either:
 - Select Selcall, enter a Selcall Id manually and press Enter, or
 - Choose a contact from the Contacts icon  and then select Selcall.
5. Wait for the Selcall to be sent and listen for the revertive signal that indicates the call was successful.
 - If a revertive tone is not heard or was difficult to hear, try another channel and repeat the process until a good channel is found.
 - If a revertive tone is heard but you receive no verbal response from the station, it may be because the Operator is unavailable at the time.



Receiving a Selcall

Note: To receive a Selcall your transceiver must be programmed for Selective Call (Selcall) and where multiple channels are in use, the scan function should be activated.

When you receive a Selcall, your station sends a reverive tone (to alert the calling station that the call was received), an audible alarm sounds, the mute (squelch) (if selected) opens and the display shows who the call is from.



The audible alarm will sound for 60 seconds unless acknowledged and then time out. To cancel the alarm and acknowledge the call, press the PTT button or



tap . If the audible alarm times out, the missed call icon displays  and a periodic audio reminder is emitted.

For details of previously received Selcalls, press and hold  to display the Call History screen. Refer to the Call History section on page 35.

Telcall

Telcall uses the digital Selective Call system to send a telephone number on a HF network. Telcalls are primarily used to send to stations equipped with a telephone interconnect unit to initiate phone calls onto the PSTN.

Sending a Telcall

1. Select the channel to send the Telcall on. This will be the channel provided by your network administrator to contact the interconnect.
2. Press  and, if necessary, press the  icon to show the Call Selection screen.



3. Either:
 - Select Telcall, enter the Selcall ID of the interconnect, select Enter phone number, enter the phone number manually and press Enter, or
 - Choose a contact from the Contacts icon  and then select Telcall. Enter the Selcall ID of the telephone interconnect, choose Select from Contact and select contact.
4. Wait for the call to be sent and listen for the revertive signal that indicates the call was successful.
 - If a revertive tone is not heard try another channel and repeat the process.
 - If the destination station is connected to a telephone interconnect, when the call is successful, wait for the telephone connection to be made and then proceed with the call.
5. Perform a Hangup Call to disconnect from the interconnect (refer to page 47 for more information on Hangup Calls).

Receiving a Telcall

Note: To receive a Telcall your transceiver must be programmed with a Self ID and where multiple channels are in use the scan function should be activated.

When you receive a Telcall, your station sends a revertive call (to alert the calling station that its call was received), an audible alarm sounds, the mute (squelch) (if selected) opens and the Telcall screen displays.

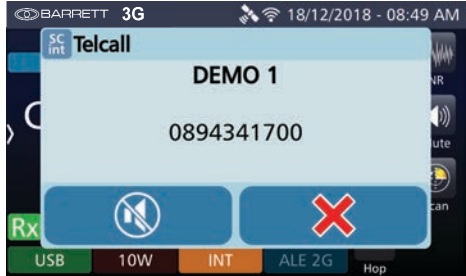

The Telcall screen shows the Selcall ID and telephone number of the caller.



Tap  to stop the audible alarm but maintain the Telcall screen.

Tap  To close the Telcall screen.

The audible alarm will sound for 60 seconds, unless acknowledged and then time out. To cancel the alarm and acknowledge the call, press the PTT button or

tap either  or  (described above). When the audible alarm times out, the call received  icon displays and a periodic audio reminder is emitted.

For details of previously received Telcalls, press and hold  to display the Advanced Call History screen.

Advanced Call History

Advanced Call History is a log of all Selcall, ALE 2G and ALE 3G call types stored in the transceiver. The log has the time of transmission, frequency and IDs of the transmitting and receiving transceivers recorded with every entry. Advanced Call History also has a 'return call' feature that directly links the call history with the transceivers call functionality whilst pre-entering the information from the selected call entry.

The Call History is also directly connected to the transceiver's contact settings, allowing calls from the same contact to be collated together - regardless of call type. This can be toggled on or off in the Call History menu.

Call History Menu

The Call History menu can be accessed via **Settings** < **Call History**.

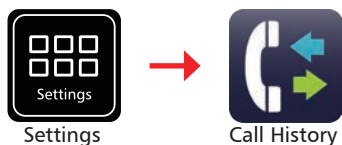

From this menu, the Advanced Call History can be accessed, deleted, updated and the collation of the call history by contact can be toggled on or off. Update advanced call history will only appear when using a remote control application (see IP Connectivity Guide P/N BCM40507).

Enabling the Collate call types function will group calls from the same contact together - regardless of call type (Selcall, ALE 2G or ALE 3G) - based on the contacts entered into the transceiver via either the programming software or the transceiver front panel (see page 26 for further details on creating contacts).

Disabling the Collate call types function will collect calls in threads based on the call type (Selcall, ALE 2G or ALE 3G) and sender regardless of whether they are entered as a contact.

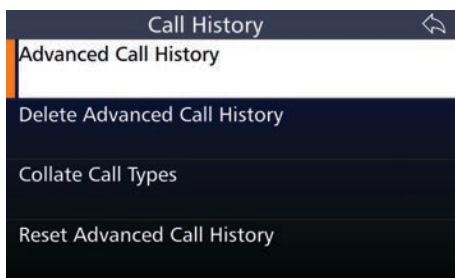

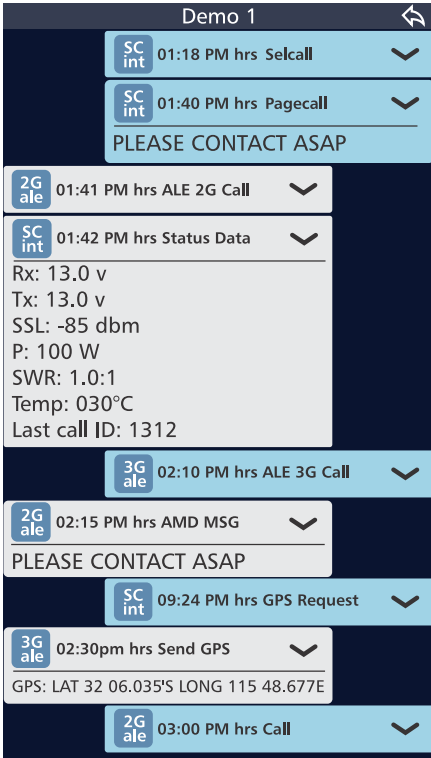

Collated Calls

Pressing an arrow reveals further information about a call including frequency, channel number, as well as to and from addresses.

Uncollated Calls

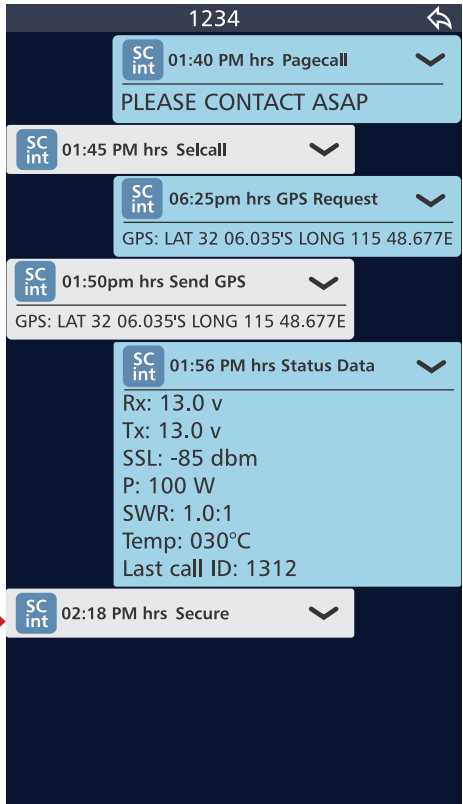





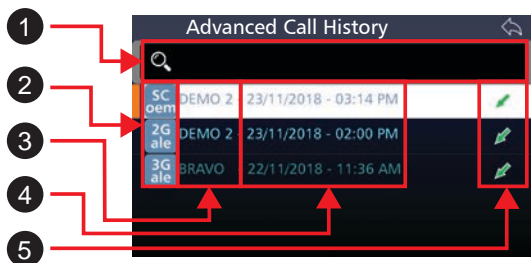

Pressing a call bubble within a thread will initiate the return call process to the sender. Please note that this function is unavailable for ALE 2G and 3G NetCalls.







Advanced Call History Menu

This menu can be accessed by either pressing and holding the **Call button for 2 seconds** or via the **Settings < Call History Menu**. Both display the same features and have the same functionality.



- | | | |
|---|---------------------------|---|
| 1 | Search | The Search function allows an operator to search the following fields: first name, surname, phone number or email address of a contact; Selcall ID, ALE 2G or ALE 3G alias; date or time of call or data type call (GPS, status, pagecall). |
| 2 | Call Type | The call types are outlined in the table below. |
| 3 | ID or Alias | This is the ID, address or Alias of the remote transceiver that the local transceiver is/was communicating with. |
| 4 | Date and time | The date and time of the most recent call in a thread are displayed here. |
| 5 | Incoming or Outgoing call | The arrows display whether the last call in the message thread was a transmitted, received or missed call. |

Icon	Description
	Call transmitted
	Call Received
	Missed Call
	Missed Call count
	Call sent and delivered at other station * For 2G and 3G only
	Call sent but not delivered at receiving station *for 2G and 3G only. The red cross indicates non-delivery as a default state until a call sent acknowledgment is received

Icon	Description
	Selcall INT format
	Selcall OEM format
	Selcall CCIR format
	Selcall RFDS format
	Emergency Selcall format
	ALE 2G format
	ALE 3G format

Adding a Contact from Call History

A contact can be added or edited directly from the Advanced Call History menu.

To add/edit a contact, press and hold the call history thread and select Add/Edit Contact.

Fill/edit the appropriate fields and save by pressing the .

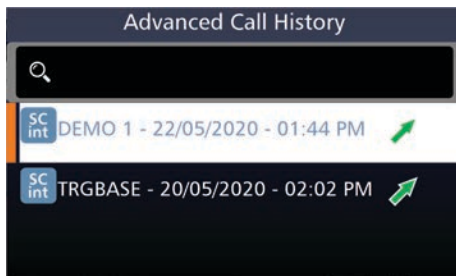

Deleting a Message Thread

Delete an entire message thread by long pressing on the thread and selecting "Delete Message Thread".

Select  to confirm or  to cancel.

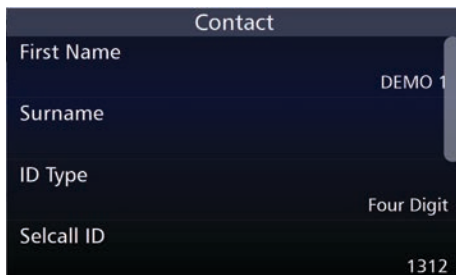
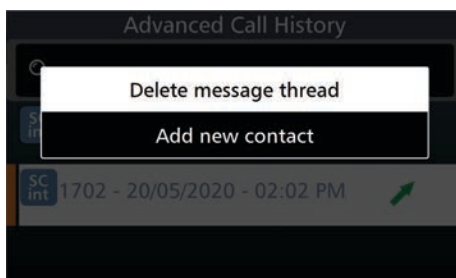

Advanced Selcall Functions

The call types and settings in this section are less commonly used but are useful in all manner of situations.

Selcall Settings

From the Settings menu, select Selcall to view the Selcall Settings for the transceiver.



Settings



Selcall

The following menu displays:

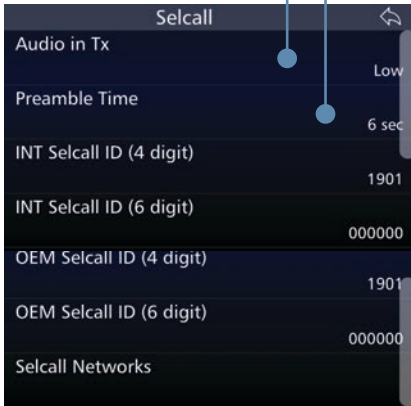

The volume of the Selcall audio during Transmit. It can be Selected as Low, High or Off.

The length of the Selcall preamble. 500ms are recommended per channel in the scan group + 1 second.

Default 4-digit INT Selcall ID. Identifies the transceiver to other users when using an INT channel.

Default 6-digit INT Selcall ID. Identifies the transceiver to other users when using an INT channel.

4-digit OEM Selcall ID. Identifies the transceiver to other users when using an OEM channel.





6-digit OEM Selcall ID. Identifies the transceiver to other users when using an OEM channel.

A list of the transceiver's Selcall IDs on saved Selcall Networks. Can be modified. See page 48.

Pagecall

Pagecall (SMS) allows messages of up to 32 characters in INT format, or 64 characters in OEM format to be sent to or received from other transceivers with Pagecall facilities.

Sending a Pagecall

1. Select the channel on which to send the Pagecall (Beacon Call can be used to determine the best channel)
2. Listen for traffic on that channel. If traffic is not heard, continue.
3. Press  and, if necessary, press the  icon to show the Call Selection screen.
4. Either:
 - Select Pagecall, enter the Selcall ID of the transceiver you wish to contact, type in the message and press Enter, or
 - Choose a contact from the  Contacts icon  and then select Pagecall. Type in the message and press Enter.
5. Wait for the call to be sent and listen for the revertive signal that indicates the call was successful.
 - If a revertive tone is not heard try another channel and repeat the process.



Receive a Pagecall

When a Pagecall is received, an audible alarm sounds, any mute is disabled and the Pagecall screen displays.



The Pagecall screen shows the Selcall ID and message.

Tap  to stop the audible alarm but maintain the Pagecall screen.

Tap  To close the Pagecall screen.



The audible alarm will sound for 60 seconds and then time out. To cancel the alarm before the time out period, and to acknowledge the call press the PTT

button or tap either  or  (described above). When the audible alarm times out, the call received icon displays and a periodic audio reminder is emitted.

When the audible alarm times out, the call received icon displays.

This message can be retrieved from the Advanced call history menu (see page 35).



GPS Request

Use this option to request a remote station's GPS position. Information from the remote station will be either the latest GPS position of the station or the following error messages:

- "GPS data not available"

The GPS Request displays the GPS coordinates of the remote station's position as well as the bearing of and distance from the receiver.

Sending a GPS Req

1. Select the channel on which to send the GPS Req (Beacon Call can be used to determine the best channel).
2. Listen for traffic on that channel. If traffic is not heard, continue.
3. Press .
4. Either:
 - Select GPS Req, enter the selcall ID of transceiver you wish to contact and press Enter, or
 - Choose a contact from  the Contacts icon and then select GPS Req.
5. Wait for the call to be sent and listen for the revertive signal that indicates the call was successful.
 - If a revertive tone is not heard try another channel and repeat the process.
6. The receiving station will transmit it's position if fitted with a GPS receiver.

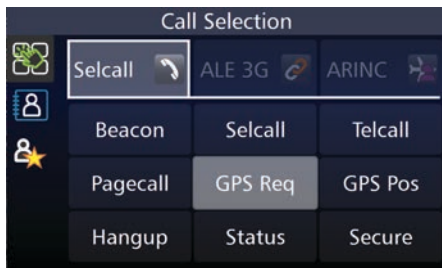

The GPS Data screen displays the caller's Selcall Alias (or alternately, their Selcall ID)

To stop the alarm sounding but

keep the display, press .

To close the screen, press .

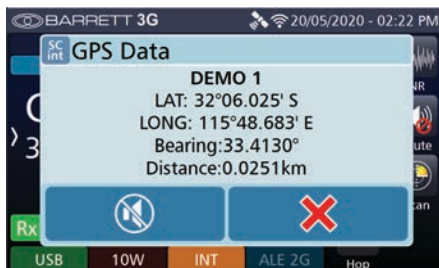



GPS Position

Use this option to send your GPS position to another station.

Note: a GPS receiver must be connected and receiving position information when using the GPS call option.

Sending a GPS Pos

1. Select the channel on which to send the GPS Pos (Beacon Call can be used to determine the best channel).
2. Listen for traffic on that channel. If traffic is not heard, continue.
3. Press 
4. Either:
 - Select GPS Pos, enter the selcall ID of the transceiver you wish to contact and press Enter, or
 - Choose a contact from the  Contacts icon and then select GPS Pos.
5. Wait for the call to be sent and listen for the revertive signal that indicates the call was successful.
 - If a revertive tone is not heard try another channel and repeat the process.



Note: If a GPS receiver is not connected or hasn't acquired a GPS signal the "GPS Pos" call type will not be available.

Status Call

A Status call allows the operational status parameters of any Barrett transceiver fitted with Selcall to be accessed. This status is sent from the remote transceiver as a Selcall with the status information embedded within the Selcall structure. Information retrieved for remote diagnosis of transceiver performance includes:

- Receive state battery voltage
- Last transmit state battery voltage
- Signal strength indication of received status request Selcall
- Forward power output level
- VSWR of the antenna
- Temperature
- Selcall ID of the last radio called.

Sending a Status Call

1. Select the channel to send the Status Call on (Beacon Call can be used to determine the best channel).
2. Listen for traffic on that channel. If traffic is not heard, continue.
3. Press **CALL**
4. Either:
 - Select Status, enter the Selcall ID of the transceiver you wish to contact and press Enter, or
 - Choose a contact from the Contacts icon  and then select Status.
5. Wait for the call to be sent and for the remote station to return its status data.

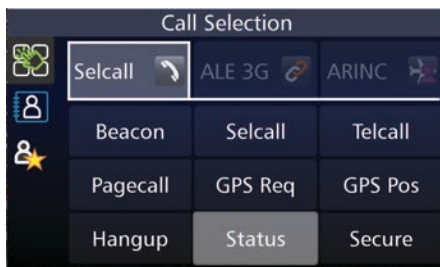

If a reply is not received, either repeat the process or change the channel and repeat.

Secure Call

The Secure Call option provides the transceiver operator with a secure speech path using an in-band hopping technique. Secure Call is simple to use requiring each radio to be setup with the same four digit "Selcall Secure Call Code".

Features:

- The Secure Call is limited to point to point and point to multi point (group call) communications between radios within a network.
- If any radio drops out of the secure call, it is not possible to re-enter the secure call. Operators can re-establish the link following the Secure Call method.

Secure Call Codes

A Secure call code is necessary to make a successful secure call. Create a Secure Call Code via Settings, Security, Secure Call Code. Type a 4 digit number.

Note: The 4 digit secure call code must be the same for both the transmitting and receiving stations.



Sending a Secure Call

1. Select the channel to send the Secure call on (Beacon Call can be used to determine the best channel).
2. Listen for traffic on that channel. If traffic is not heard, continue.
3. Press 



4. Either:

- Select Secure, enter the Selcall ID of the transceiver you wish to contact and press Enter, or
- Choose a contact from the Contacts icon  and then select Secure.

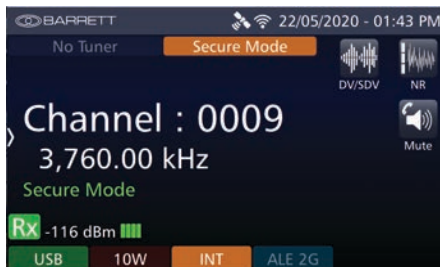

5. Listen for the secure call revertive tone from the called station which indicates the call was successful.

Note: The secure call revertive tone has a different sound to the revertive tones of the other call types.

If the revertive tone was not heard, try another channel and repeat the process.

Now the transceivers can communicate securely using a voice call. Other users on the frequency will only hear garbled speech.

To exit secure mode, either a Hangup call can be sent or press the “back” key.

Hang-up Call

When a call to a telephone interconnect base station has completed or a secure call link is complete, the operator should ‘hang-up’ by sending a hang-up code to a telephone interconnect or secure call linked transceiver.

Note: If the hang-up call is unsuccessful for any reason, the telephone interconnect will time out and hang-up automatically. There is no time out once linked.

Sending a Hang-up Call

1. Press 
2. Select Hangup and enter the Selcall ID of the station you wish to disconnect from. Listen for hang-up revertive tone which confirms the disconnect was successful.



Sending the Hangup call from either secure call linked transceivers will disconnect both transceivers from secure call mode.

Selcall Networks

The Selcall Network screen is a list of the transceiver's 4 and 6 digit IDs on various HF networks. These are programmable and up to 5 networks can be stored on the transceiver.

Creating a New Selcall Network

1. Access the menu via **Settings** and **Selcall**. Select **Selcall Networks**.



2. Tap the + symbol to create a new Selcall Network.
3. Selcall Network Alias refers to the name of the network on your transceiver. This is not read or transmitted by any external transceivers or displayed when you transmit.
4. Selcall Format chooses whether the network transmits over INT, CCIR, OEM or RFDS frequencies. All transceivers in the network will need to be the same in order to transmit between each other.
5. The Selcall IDs on each network may be specific to each network. These will generally be provided by the network administrator.
6. Select the green tick and then Yes to save the Network.

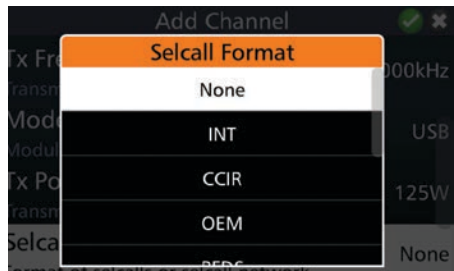
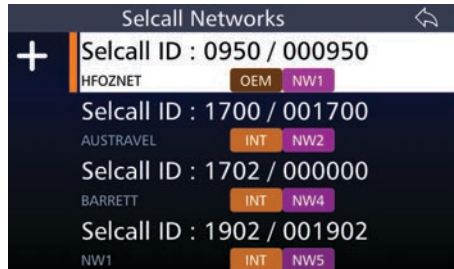

Editing an Existing Selcall Network

To edit a Selcall Network, select the desired network and either tap the network or press  from the keypad.

The Selcall Network screen displays. Edit the details as described above (for Creating a New Selcall Network).

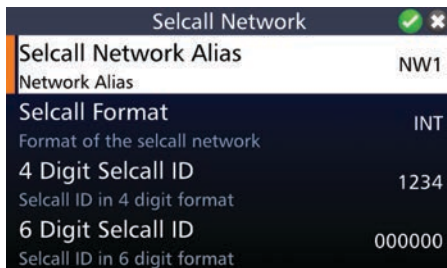

Deleting an Existing Selcall Network

Select the Selcall Network to be deleted, then tap and hold for three seconds.

A confirmation message displays.

Tap  .

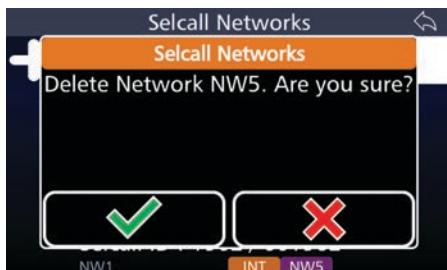

BASIC SETTINGS 4

This chapter contains the following sections:

- System Information
- General Settings
- Audio Settings
- Display Settings

System Information

Select **System Info** from the Settings menu to display the System Information screen.

Some items will not be displayed, unless installed.



Settings



System Info

Head Device ID

This displays the name of the control head. This name is used to differentiate between primary and secondary heads.

Serial Number

This displays the transceiver's serial number.

Version Information

This menu provides software and firmware version numbers. Contact your Barrett provider for more information

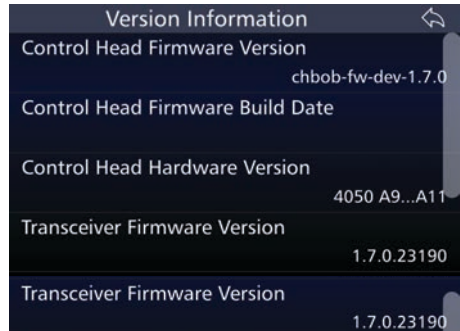

Transceiver Options

This menu displays the installed options present in the transceiver. The image opposite shows all possible options.

From this menu, option PINs (supplied by Barrett Communications) can be entered to activate inactive options.

To activate an inactive option, please contact Support at Barrett Communications at:

support@barrettcommunications.com.au.



Configuration Pack Information

This menu offers easy identification of the transceiver's current pack and when it was last updated.

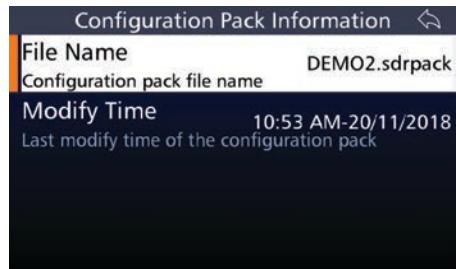

SDV/4026 Serial Number

This provides the serial number of the SDV/4026 hardware module fitted in the transceiver.

General Settings

Select **General** from the Settings menu to display the General Configurations screen.

A list of items that may be configured is displayed. To reveal more items, either swipe down on the touch screen or press .

The current status of each of the items is displayed on the right.

Note: this menu will appear differently when using the 4000 Series Remote Control Software.

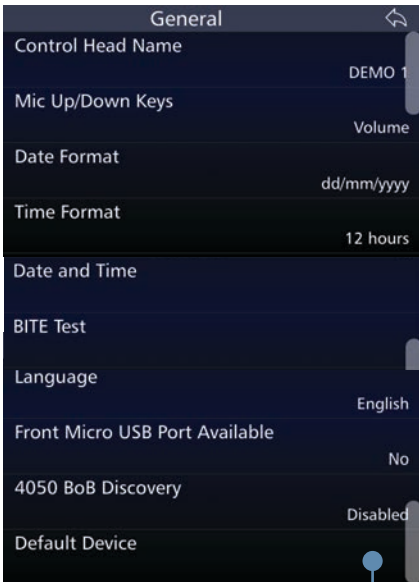

- Modifiable name for the transceiver. This name will be used to refer to this transceiver on external networks.
- Controls the function of the arrow keys on the side of the hand held microphone. Can control either channel or volume.
- Sets the format in which the date is displayed on the transceiver to one of five options.
- Toggles the time format between 12 and 24 hour displays. This displays on the transceiver front panel.
- Sets up the date, time and timezone displayed on the transceiver. Swipe up or down on the touchscreen to modify.
- Built in Testing Equipment. Provides a basic indication of faults in the system. See Appendix 4, page 162.
- Language of the transceiver's display.
- Dependant upon the 4050 hardware version. Select Yes, if available.
- For use with a Barrett Break-out-Box. If BoB is connected, select Enable.
- Will revert transceiver back to factory settings. All channel info, ALE2G/3G info, all security PINs and encryption keys will be cleared.

Audio Settings

Tap **Audio** from the Settings screen to display the Audio screen.

A list of items that may be configured is displayed.

The current status of each of the items is displayed on the right.

To reveal more items, either swipe down on the touch screen or press



Settings



Audio

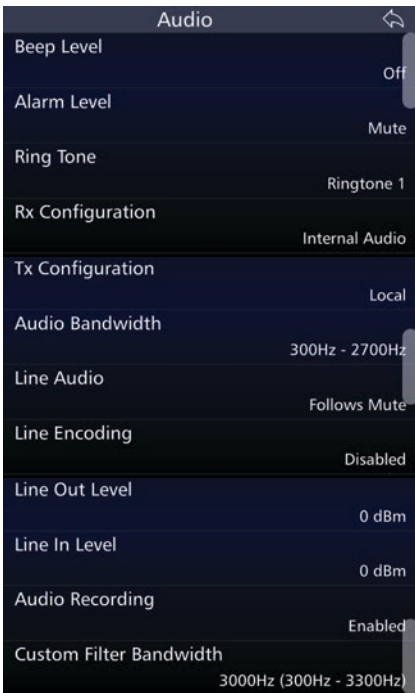

Volume level for the Key tones. Can be configured as Low, High or Off

Volume control for the incoming Audio Alarm. Can be configured as Low, Med, High or Mute.

Choose 1 of 7 ring tones for the incoming alarm tone.

Advanced Operations. For more information, see page 67.

Display Settings

Tap **Display** from the Settings screen to display the Display screen.

This menu can also be accessed via the swipe screen, provided that the GPS Push option is not enabled.

A list of items that may be configured is displayed.

The current status of each of the items is displayed on the right.



- Adjusts the brightness of the screen backlight. Can be configured as Low, Med, High and Very High.
- Length of time before the Display timeout behaviour activates. Can be configured as Short Timeout (1 min), Long Timeout (3 min) or Always On.
- Behaviour of the screen activated when the backlight times out. Shows screensaver, dims or switches off display.
- The preferred unit to display the Transmit Wattage. Either Watts or Chevrons.
- The preferred unit for displaying the received signal strength. dBm, uV or S Meter.
- Preferred unit of temperature for the transceiver. Celcius or Farenheit.
- Changes the display format for the GPS coordinates in the swipe menu
- Changes the displayed units of distance for the GPS between Kilometres, miles and nautical miles.
- Changes the display orientation between portrait or landscape modes.
- Changes the display theme between default, red, green or dark green.
- See advanced settings page 97

PROGRAMMING 5

This chapter contains the following sections:

- Channel Programming
- Free Scroll Rx/Tx
- Programming via USB

Channel Programming

The programming of channels is restricted in some countries. In this situation, transceivers will be pre-loaded with a channel pack and this function will be locked in the transceiver menu.

If the transceiver is unlocked, there are three ways to program channels into the transceiver.

1. Manually through the transceiver's front panel,
2. By inserting a USB storage device containing the appropriate files into the transceiver's USB socket (see page 64)
3. By using the Barrett Programming Software (P/N BCA40001). This option is not available in all countries. Please check with your Barrett dealer for your location. For more information on using the Barrett 4000 Series HF Programming Software, please refer to the 4000 Series HF Programming Software Manual (P/N BCM40503).

Programming Channels Through the Front Panel

Tap **Channels** from the **Settings** screen to display the Channels screen.

A list of currently used channels is shown displaying channel number, frequency, and channel label.

ALE channels appear greyed out and cannot be edited from this menu.



Adding a new channel

To add a channel, tap  to display the Add Channel screen.

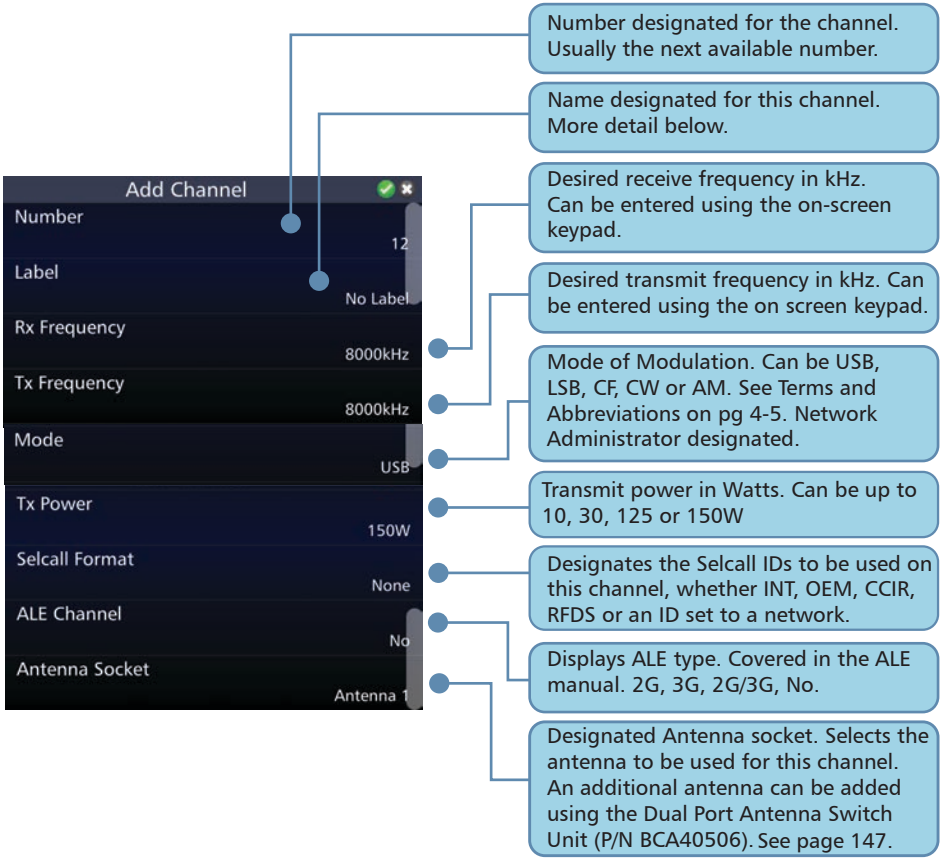

The screenshot shows the 'Add Channel' screen with the following fields and values:



Field	Value
Number	12
Label	No Label
Rx Frequency	8000kHz
Tx Frequency	8000kHz
Mode	USB
Tx Power	150W
Selcall Format	None
ALE Channel	No
Antenna Socket	Antenna 1

Callouts provide the following details for each field:

- Number:** Number designated for the channel. Usually the next available number.
- Label:** Name designated for this channel. More detail below.
- Rx Frequency:** Desired receive frequency in kHz. Can be entered using the on-screen keypad.
- Tx Frequency:** Desired transmit frequency in kHz. Can be entered using the on screen keypad.
- Mode:** Mode of Modulation. Can be USB, LSB, CF, CW or AM. See Terms and Abbreviations on pg 4-5. Network Administrator designated.
- Tx Power:** Transmit power in Watts. Can be up to 10, 30, 125 or 150W
- Selcall Format:** Designates the Selcall IDs to be used on this channel, whether INT, OEM, CCIR, RFDS or an ID set to a network.
- ALE Channel:** Displays ALE type. Covered in the ALE manual. 2G, 3G, 2G/3G, No.
- Antenna Socket:** Designated Antenna socket. Selects the antenna to be used for this channel. An additional antenna can be added using the Dual Port Antenna Switch Unit (P/N BCA40506). See page 147.

After configuring the above attributes, tap  to add the channel. A confirmation message displays. Tap **Yes**.

Editing a Channel

To edit a channel, select the desired channel by using the  and  keys from the Channel screen and either tap the channel or press  from the keypad.

Note: Attempting to edit an ALE channel will result in an error message. ALE channels can only be edited from the ALE menu. See Barrett ALE 2G and 3G User Guide (P/N BCM40524).

The Channel Information screen displays. Edit the fields as desired.

Deleting a Channel

To delete a channel, tap and hold for three seconds the channel you wish to delete. A confirmation message displays.

Tap **Yes**.

Label

Channel labels are used to name a channel and remind an operator what the channel is used for eg. UNHCR Geneva.

Channel Labels must be created under the labels menu before they can be applied to a channel.

Adding a New Label

Tap **Labels** from the **Settings** screen to display the Channels screen.



To create a new label, tap the  icon from the Settings<Labels menu.

Type the new label using the on screen keyboard.

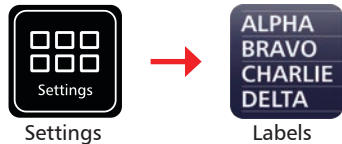
This label can now be added to a channel.



Editing an Existing Label

To edit a channel label from the Channel Labels' screen, select the label by using the  and  keys and either tap the label or press  from the keypad.

Use the keyboard to edit the name of the label, then tap  to save.



Deleting an Existing Label

To delete a channel label from the Channel Labels' screen, select the channel label you wish to delete, then tap and hold for three seconds.

A confirmation message displays.

Tap **Yes**.



Mode

Network administrators designate usable channels and modes as one of the following:

USB - Upper Side Band.

LSB - Lower Side Band.

CF - Custom Filter.

CW - Continuous Wave (Morse code).

AM - Amplitude Modulation.

Free Scroll Rx/Tx

Frequency Selection

Free Scroll Rx is a feature that allows a user to scroll through frequencies in a receive-only capacity. If the “Free Scroll Tx” option is enabled, pressing PTT will allow transmit on the selected frequency. Transmit exclusion zones (frequencies where an operator cannot transmit) can be set via the 4000 Series Programming Software (P/N BCA40001).

From the home screen tapping the channel frequency will open the Free Scroll function.

This can be navigated in two ways:

- The directional buttons
- The power button/volume control dial
- Tapping the digits

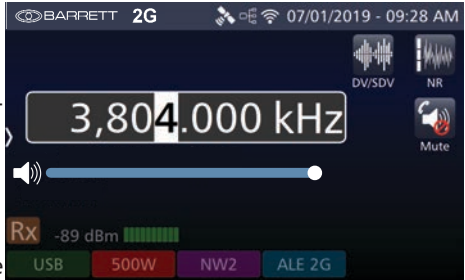

Directional buttons

The left and right arrow keys change which digit is highlighted.

The up and down keys change the value of the highlighted digit.

Power Button/Volume Control Dial

Turning the volume dial either changes which digit is selected or the digit's value.

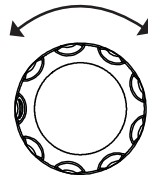

Pressing the power button switches between the two dial functions.

Note: In this mode, the power button no longer operates as the on/off switch for the transceiver. To power off the transceiver, exit this mode by pressing the back key and then the power button.

Adjusting the Volume

As the volume dial serves another function, volume can only be adjusted by dragging the white indicator along the blue sliding bar.

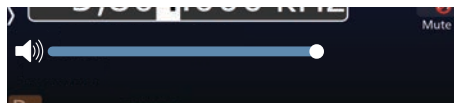

Note: The Free Scroll menu can be locked in the 4000 Series HF Programming Software and, if locked, will not appear when the frequency is pressed.

Adding a Channel from the Free Scroll screen

A channel can be added directly from the Free Scroll screen. When a desirable frequency is found, pressing  on the front panel will allow the frequency to be added at the next available channel number.

All of the fields can be set, as when programming a channel from the channel menu (see "Channel Programming" on page 58).

Press  to save the channel.

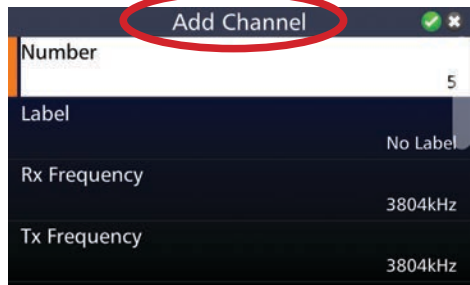

Free Scroll Scanning

By holding the Scan icon, the scan settings for Free Scroll can be set.

Scan Rate indicates the time spent on each frequency.

Scan Step Indicates the interval between frequencies scanned.

Tapping the scan icon will initiate scanning.



Scan

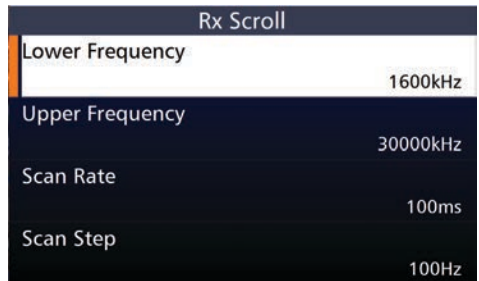

Programming Via USB

The transceiver configuration can be imported or exported as a “pack”. This contains the channel configurations, ALE 2G/3G settings, scan tables, contacts and settings amongst other information.

Note: a valid USB storage device must be inserted to activate.



Exporting Settings to a USB

To export the device’s configuration settings, insert a USB storage device into the device’s USB socket.

1. Tap **Settings**, then **Export**.



2. From the Export screen, tap **Export Configuration** to display the Configuration File Name screen.

The default name displays. Use the keyboard to type an alternative name of the configuration file to export to the USB storage device.

Tap  to save.

3. Enter an optional password to encrypt the exported pack.
4. The Export Configuration screen displays showing a progress bar confirming the progress of the export.

When prompted, tap **OK** and remove the USB storage device.

Importing Settings from a USB

1. With a USB storage device inserted into the USB port, tap **Settings**, then **Import**.

If the correct files are on the USB, the transceiver will recognize them and initiate the Import/Update screen.

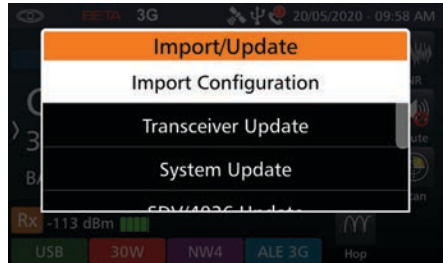

2. To update the configuration settings (pack), tap **Import Configuration** from the Import/Update screen described above.

Select the required file to import.

If a password was set up for the pack, this will be required for the import to complete.

Confirm that the call history will be replaced when the new pack is loaded.

3. The import process will then begin automatically showing a progress bar. Remove the USB storage device when prompted.
4. The importing of a pack via USB is complete.

ADVANCED OPERATION 6

This chapter contains the following sections in alphabetical order:

- ARINC Call
- Audio - Advanced
- Collective Call
- Digital Voice
- Export
- Frequency Hopping
- I/O Settings
- Modes
- Mute (Squelch)
- Network
- Noise Reduction (NR)
- RF Settings
- Scanning
- Screen Capture and Re-sync
- Security Settings
- Stealth Mode
- Theme Schedule
- Tuning

ARINC Call

An ARINC call functions in much the same way as a Selcall. It is a hailing or alert system used exclusively to alert aircraft.

An ARINC ID is a sequence of two sets of 2 letters. Each pair must be entered alphabetically eg. AB-CD or CD-AB.

The interface does not allow invalid ARINC IDs to be entered and blanks out invalid characters.

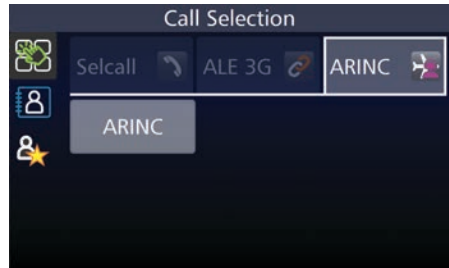

Audio - Advanced

From the **Settings** menu, select **Audio**.

For information on Beep Level, Alarm Audio Level and Ring tones, see Basic Settings page 51.



Rx Configuration

This option sets whether the transceiver receives audio via the antenna or from the Line.

Selecting “Internal Audio” ensures the transceiver receives audio through the antenna.

For “External Audio”, the transceiver receives through the auxiliary socket’s 600 ohm balanced audio port. This can be used in many situations, e.g: for a remote receiver in split site operations where audio is received from the remote site.

Tx Configuration

This option sets whether the 4050 transmits to the antenna or down the line.

When set as “local” the transceiver transmits through the antenna.

When set as “remote”, the transmit audio is sent through the auxiliary socket’s 600 ohm balanced audio port.

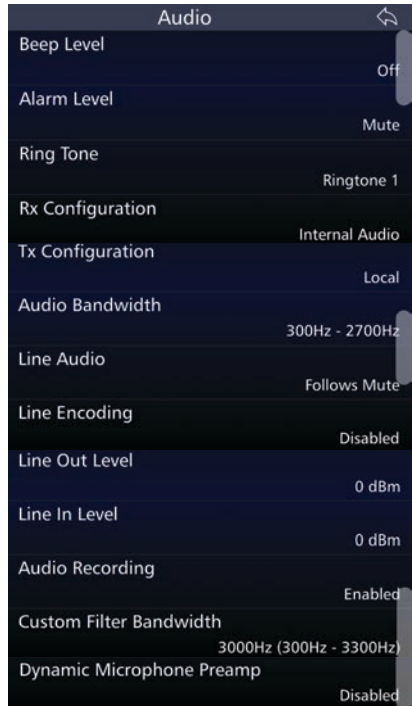

Audio Bandwidth

This section allows the audio bandwidth to be tailored to an operator’s requirements.

Select either:

- 300 Hz - 2700 Hz: used for reduced bandwidth voice operation
- 300 Hz - 3000 Hz: standard voice and data operation
- 300 Hz - 3200 Hz
- 300 Hz - 3400 Hz

Line Audio

This option sets the muting condition of the 600 ohm balanced audio line output on the rear auxiliary connector.

The line output can be set to Unmuted or Follows Mute. When set to Follows Mute, the line output is muted in the same manner as the speaker output and follows the mute condition currently in use. The line output is usually set to Unmuted when using data modems. Follows Mute should be selected when the transceiver is being used with 2062 Crossgate.

Line Encoding

When this is selected, the Line audio will also be processed through the Digital Voice hardware.

Line Out Level

This setting adjusts the output level of the auxiliary 600 ohm balanced audio output port.

Line In Level

This setting adjusts the input level sensitivity of the auxiliary 600 ohm balanced audio input.

Audio Record

This option is used to monitor conversations. It utilises the line audio to listen to the received and transmitted audio. Connect an appropriate device to record the conversation using a cable (up 1.2 m in length) with connection specification below.

DB 25 Male Connector Pin	Description	3.5mm Jack Connector Pin
12	Summed Record Audio	Tip & Ring
25	Ground	Sleeve

Custom Filter Bandwidth

This section allows the audio filter bandwidth to be tailored to an operator's specifically required frequency range. Note that the range must be a minimum of 300 Hz.

Dynamic Microphone Preamp.

This setting is to be enabled when using the BCA40011 Desktop Microphone. At all other times, set to disabled.

Collective Call

Collective calls comprise of all-calls, group calls and sub-group calls which involve calling a number of Selcall IDs simultaneously. This is not an individual button in the Selcall menu as a transceiver can group call as a number of call types. For information on other call types please refer to Chapter 3 - Selcall, page 21.

Note: All call, Group call and Sub-group call must be enabled in the Barrett 4000 Series HF SDR Programming Software (P/N BCA40001).

Sending a Group Call

It is recommended that transceivers should NOT be programmed with a Selcall ID ending in "0" as this is used for making group calls. When prompted to enter a Selcall ID for a chosen call type, the first digits represent the groups of IDs you wish to contact.

Four Digit format

All call

eg. Entering 2000 will contact every transceiver on the channel with an ID that begins with "2".

Group call

eg. Entering 2300 will contact every ID on the channel that begins with "23".

Sub-group Call

eg. Entering in 2310 will contact every ID that begins with "231".

Six Digit format

Same as above. No more than the last 3 digits can hold the 0 value.

eg. Entering 123000 will contact every transceiver beginning with "123".

Digital Voice (Encoding)

Encoding can improve the reliability of communications over noisy channels where reception of analogue voice can be very poor. Poor voice quality can be improved markedly by the use of digital voice modules to the point where barely usable frequencies are made clear. Secure Digital Voice allows users to encrypt their communications over HF therefore providing a secure HF network.



Encoding
off



Encoding
on

Both Digital Voice and Secure Digital Voice capability can be utilised in Barrett 4000 and 2000 series HF Transceivers using Barrett digital voice modules which are designated as:

- DV Digital Voice module with no encryption
- SDV-56 Secure Digital Voice module with DES 56 encryption
(No export licence required)
- SDV-256 Secure Digital Voice module with AES 256 encryption
(Export licence required)

Signal-to-noise ratio conditions can change during communications between HF stations. The digital voice modules have auto baud capabilities which automatically adjust baud rates up or down whilst communicating between the transceivers allowing the users to transmit and receive signals with optimal voice clarity.

For more information on Digital Voice, please consult the Barrett HF Radio Digital Voice and Secure Digital Voice Operating Manual (P/N BCM40504).

Export

Aside from exporting the 4050 configuration settings (pack), the export function of the 4050 can also be used for diagnostic purposes. Diagnostic and log files can be exported and sent to Barrett Communications.

The Android version of the Barrett 4000 Series Remote Control App can be downloaded directly from the transceiver head. For further information please consult the Barrett 4000 Series IP Connectivity Guide (P/N BCM40507).



Frequency Hopping

This option requires an Export Permit.

Frequency hopping can be used to limit performance degradation due to interference and to reduce the likelihood of interception. Frequency Hopping Spread Spectrum (FHSS) is a method of transmitting radio signals by rapidly switching a carrier among many frequency channels.

The transceiver employs a unique frequency hopping system that uses an external GPS.

Note: An external GPS must be connected and providing valid data for the frequency hopping system to operate.

Selecting the Hopping Band

Select the channel used for normal/clear transmissions based on the normal procedures used when using an HF system. This channel frequency and mode is used by the Transceiver to determine the hop band. For further information, see page 93.

Entering the Hopping PIN

This code is entered under Settings < Security (see page 92). All of the transceivers that will be communicating on the same hopping band will need to have the same Hopping code.

Frequency Hop Rate

The Frequency Hop Rate is the rate at which the frequency hops between transmission frequencies.

Select either Standard (5 hops per second) or High (25 hops per second) from the Security menu (see page 93).

Enabling and Disabling Hopping

1. Attach a GPS receiver to the rear of the transceiver.
2. Select a channel with a transmit frequency (i.e. not disabled).
3. Enter the Hopping Pin
4. Press the Hopping icon on the transceiver home screen to activate Hopping.



Hop

Hopping voice communication can now be used.

Pressing the Hopping key for a second time (or pressing the back button) disables Hopping mode.

GPS Push

GPS Push is an additional option used in conjunction with the Barrett 4077 HF Map & Track Software and provides automated transmission of GPS location at set intervals. These intervals can be programmed using the Barrett 4000 Series Programming Software (P/N BCA40001).

When enabled, this option can be toggled on or off from both the Swipe menu and the Settings menu.

For further information, please contact Barrett Communications.



GPS Push State

GPS Push state enables or disables the automatic transmission of the GPS location.

Privacy Key

This allows the input of the GPS privacy key. This privacy key allows the transmission to be DES56 encrypted, so long as the receiving station has the same privacy key in order to decrypt the transmission (DES56 encryption does not require export approval).

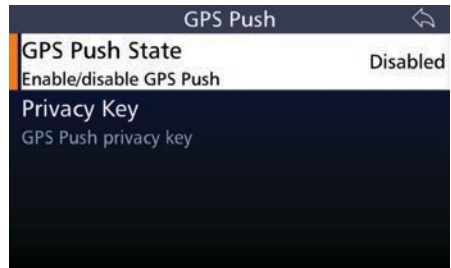

IO Settings

Tap **IO** from the **Settings** screen to display the IO screen.

A list of items that may be configured is displayed.

The current status of each of the items is displayed to the right.

To reveal more items, either swipe down on the touch screen or press

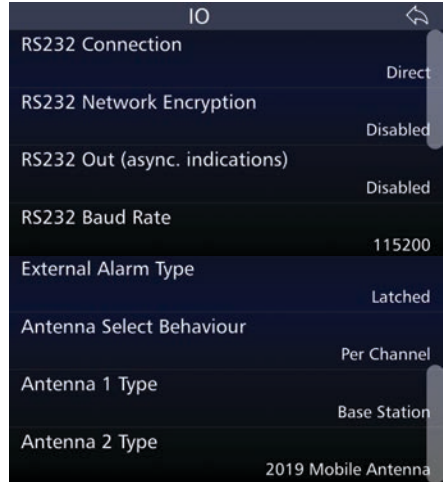
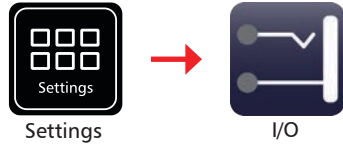

RS232 Connection

This selects whether the RS232 connection is made via a direct connection to the rear of the 4050 or via a network (WiFi or Ethernet - please see 4000 Series IP Connectivity/Networking Guide [P/N BCM40507]).

RS232 Network Encryption

Enabling RS232 Network Encryption secures information transfers over RS232 networked connections. Disabling this feature removes any encryption from the RS232 network.

RS232 Out (async. Indications)

This setting enables or disables RS232 status information output from the transceiver via the 25 pin auxiliary connector.

Note: This command does not enable/disable RS232 control of the transceiver when the RS232 option is fitted. It is used to control the output of status information via RS232 used by some external programs such as vehicle tracking.

RS232 Baud Rate

This menu option allows the selection of the RS232 Baud rate.

The Baud rate setting is dependent on the external device/application connected to the transceiver.

Tap **RS232 Baud Rate** from the IO screen to display the RS232 Baud Rate screen.

Select either: 9600 or 115200.

External Alarm Type

This sets the action of the external alarm output when a Selcall is received by the transceiver. It can be set to either a pulse output (for use with a horn) where the output is activated 15 seconds on, 15 seconds off; or a constant output (for use with a rotating beacon). Both are reset by pressing  or the PTT button.

Select either: Latched or Pulsed.

Antenna Select Behavior

This master setting can override the pre-programmed channel antenna selection. This setting is designed to be used in conjunction with the Dual Port Antenna Switch Unit (see page 147).

Select:

Per Channel (default): Antenna selection operates as per channel programming.

Antenna 1: All channels, regardless of programming, will transmit/receive using Antenna 1.

Antenna 2: All channels, regardless of programming, will transmit/receive via Antenna 2.

Antenna 1

For Antenna 1 see page 16.

Antenna 2

This option is only active if connected to a Dual Port Antenna Switch Unit (P/N BCA40506).

Note: 4075 Linear and 4075 Linear with ATU are not available for Antenna 2 Type.

Select an antenna type from the following:

Antenna Type	Select when...
Base Station	Base station antennas such as the Barrett 912 series are used. No tuning signals are emitted on channel change.
910 Mobile Ant	Using a Barrett 910 automatic tuning mobile antenna
911 Auto Tuner	Using a Barrett 911 automatic tuner
2019 Mobile Ant	Using a Barrett 2019 automatic tuning mobile HF antenna
2018 Loop Ant	Using the 2018 Mobile magnetic loop HF antenna
4011 Auto Tuner	Using a Barrett 4011 automatic tuner
4017 Auto Tuner	Using a Barrett 4017 automatic tuner
OEM Tuner	3040 tuner compatible (non-Barrett product)
Disabled	Antenna 2 not used

Modes

The current mode of transmission is displayed in the lower left hand corner (green background). The example opposite shows the transceiver in USB mode.

Pressing and holding the mode will allow an operator to change the mode to USB, LSB, CF, CW or AM mode for the current channel

Note: The mode icon will only temporarily set the mode for a selected channel, reverting to that channel's programmed default mode after the channel is changed, or the transceiver is turned off.

For further information on setting up modes for channels, see page 61.



Mute

The mute function suppresses the channel noise heard by the operator. It is designed to open (allow noise) when the transceiver detects audio or a call (depending on the mute type selected).



Mute

There are three types of mute available from the Home Screen.

Press and hold the active mute icon to select from one of the following three mute types:

- **Voice Mute** When using analogue voice, Voice Mute allows audio only when speech is detected on the selected channel. When Digital Voice is active, Voice Mute additionally opens for digital signals.
Note: The voice mute sensitivity can be set to three levels.
- **SSL Mute** Allows audio only if signal strength exceeds the nominated threshold (analogue or digital signals).
Note: The signal strength mute level can be set to three levels.
- **Call Mute** Allows audio when a call is received by the transceiver. When Digital Voice is also active, Call Mute allows audio only when digital voice traffic is detected.

The example opposite shows SSL Mute.

After two seconds, the Mute indicator is hidden and replaced by the channel label.



Each mute type has two mute states: Enabled or Disabled. However, the Enabled state can be either open or closed. Each of these states is further described below.

Enabled and Closed: No transmission audio is currently being detected by the radio. No sound is heard.

Enabled and Open: Transmission audio has been detected by the radio. This state is temporary and will automatically revert to mute (Enabled and Closed) state once audio is no longer detected.

Disabled: Audio is not censored and all noise can be heard.

Tapping the mute icon will toggle the mute state between Enabled and Disabled.

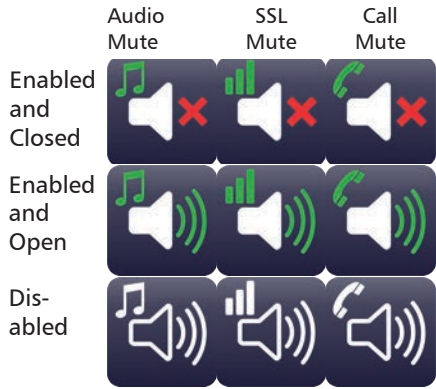

Tapping **Mute** from the **Settings** Menu displays the Mute settings screen.

Voice Mute Sensitivity refers to the “hardness” of the voice mute and its sensitivity to voice activity on a channel.

Signal Strength Level refers to the level at which the mute (squellch) opens. When set to low, the mute will open on a relatively low level of received signal. For high, the mute will open for a relatively high level of received signal.



Network

This menu can be accessed from the **Settings** menu.

From here, IP and network settings can be set.

The 4050 HF SDR Transceiver has the ability to interface with IP networks, allowing mobile cellular handsets, tablets and desktop PCs to connect directly to the transceiver via Ethernet or WiFi with the use of specialised adapters. The current range of WiFi and Ethernet adapters replaces the Ethernet connectivity provided by the Barrett Break out Box (discontinued as of April 2019) (P/N BCA40050). For more information, see the Barrett IP Connectivity and Networking Guide (P/N BCM40507).

The following diagram represents possible connections between the Barrett 4050se HF SDR Transceiver and an IP network.

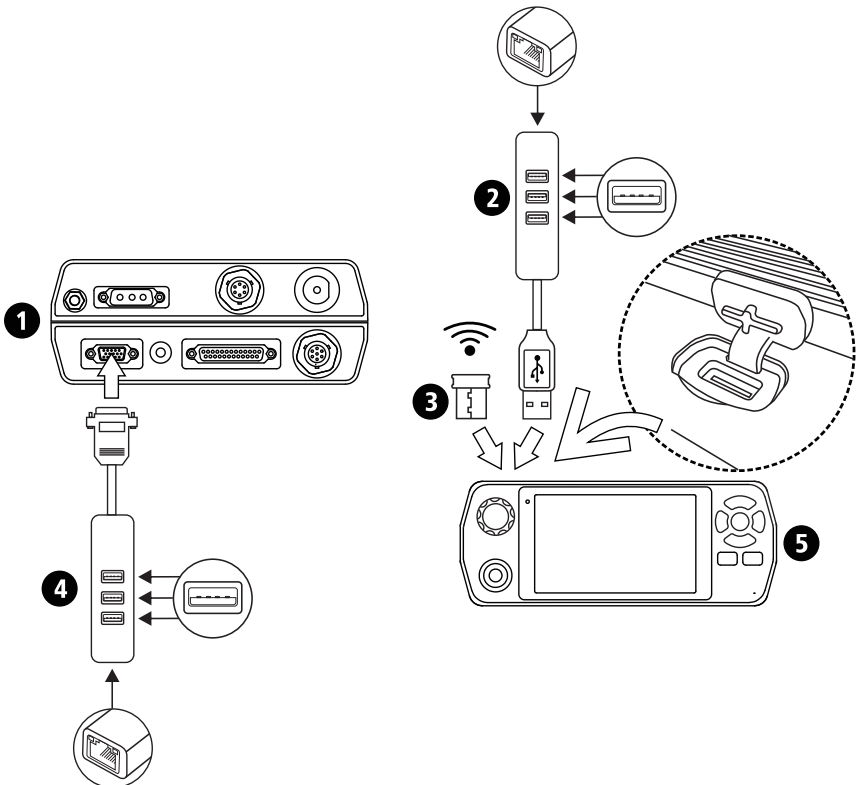

- 1 Barrett 4050se HF SDR Transceiver (rear) (P/N BC405000se)
- 2 USB to Ethernet Adapter with USB ports (P/N BCA40505)
- 3 WiFi Adapter (P/N BCO40508)
- 4 4050 to Ethernet adapter with USB ports (P/N BCA40504)
- 5 Barrett 4050 HF SDR Transceiver (front) (P/N BC405000)

This diagram represents the connection between a Barrett 4050ip HF SDR Transceiver and an IP network.

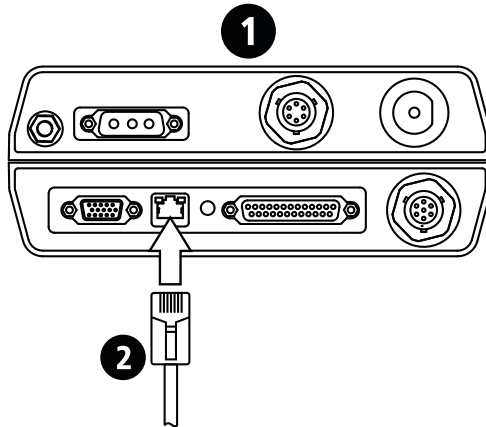

- 1 Barrett 4050 HF SDR Transceiver (rear) (P/N BC405000ip)
- 2 Ethernet (RJ45) cable

Noise Reduction (NR)

Selecting **NR** from the front panel allows the Digital Signal Processor (DSP) noise reduction depth to be adjusted to suit the operator's requirements.

Tap **NR** from the Home screen to cycle through the options: Off, Low, Medium, or High.

The example shows a NR set to High.

After two seconds, the NR indicator is hidden and is replaced by the channel label.

When the noise reduction system is active (low, medium or high) the NR icon displays an indication of the setting.



NR



NR
Off

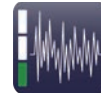

NR
Low

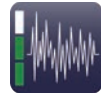

NR
Medium

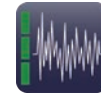

NR
High

RF Settings

Tap **RF** from the **Settings** menu to access the RF menu.

A list of items that may be configured displays.

The current status of each of the items is displayed to the right.

To reveal more items, either swipe down on the touch screen or press



Settings



RF

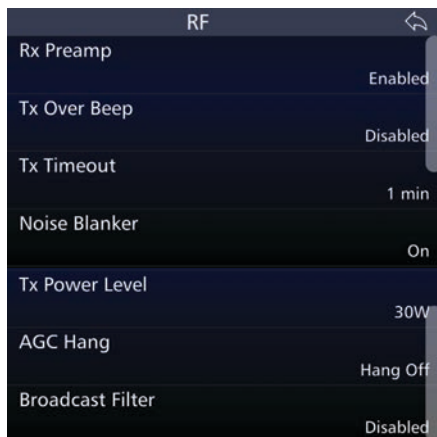

Rx Preamp

Enables or disables the Rx pre-amplifier. The pre-amplifier provides an additional receiver gain of 5 dB. Generally, the RF pre-amplifier is switched off when an automatic mobile antenna is in use as these antennas have a built-in RF pre-amplifier.

Tx Over Beep

When this option is selected, the transceiver transmits a short tone after the PTT button is released. The tone provides an audible indication to the Operator at the remote station that the local station has stopped transmitting.

Tx Timeout

When this feature is enabled, the transceiver will stop transmitting if the PTT button is held on for more than the allowed time limit eg. if the handset is accidentally wedged under a seat. Releasing the PTT button will re-enable transmission.

Set the maximum transmit time to either one, two, or three minutes. Alternatively, this transmit timeout can be disabled.

Noise Blanker

This setting allows the predictive noise blanker to be switched on or off. The noise blanker is useful to reduce repetitive vehicle related electrical interference eg. noise from a windscreen wiper motor.

Note: The noise blanker will not be effective in situations where for example, external power line noise is blanketing the receiver.

Select either: Off or On.

Note: In certain situations, noise blankers can cause intermodulation in receivers. In these cases the noise blanker should be disabled.

Tx Power Level

This section sets the global RF power output for all channels in the transceiver.

Select either: 10 W, 30 W, 125 W, or 150 W.

AGC Hang

Automatic Gain Control (AGC) Hang delays the AGC system's gain response after a signal level decreases to zero. This prevents receiver noise for the hang period.

Select either: Hang Off or Hang AGC.

Broadcast Filter

With the Broadcast Filter enabled, strong broadcast signals below 1.6 MHz will be filtered out.

Select either: Disabled or Enabled.

Scanning

Scanning allows the transceiver to monitor several channels for incoming calls. It is particularly useful as the nature of HF signal propagation means that not all channels are available for communications at one time. For example, a station calling a station that is in scanning mode can send a Beacon Call on any channel knowing the station it is calling is monitoring all its available channels. A response from the scanning station will only occur on channels that are open for communication.

Stations in scan can also monitor channels for voice activity or signals received that has a signal strength over a preset level.

The transceiver will come out of scanning mode for the following reasons:

- A Selcall is received.
- Signal Strength Level (SSL) mute is selected and a signal with a level greater than the pre-set threshold is received.
- Audio (syllabic) mute is selected and a voice signal is detected.

The **Scan icon** on the Home screen, once pressed, initiates scanning channels according to the currently selected scan table. If no scan tables are available, see Scan Settings page 88.



Scan

Whilst scanning, several options on the screen are hidden (Channels, Hop and Tune) and the Scan icon is animated.

To stop scanning, press  or the scan icon.

Pressing the Scan icon for longer than 1 second will bring up 1 of 3 possible screens:

- The Scan Settings menu (see “Scan Settings” section on page 88) when ALE 2G or 3G are not enabled.
- A list of the available ALE 2G Preset Maps when ALE 2G is enabled (See Barrett ALE 2G and 3G User Guide (P/N BCM40524)).
- A list of the ALE 3G Pool entries (See Barrett ALE 2G and 3G User Guide (P/N BCM40524)).

Scan Settings

To display the Scan Settings, select **Scan** from the **Settings** Menu.

Tap **Scan** from the Settings screen to display the Scan screen.

A list of items that may be configured is displayed. To reveal more items, either swipe up on the touch screen or press .

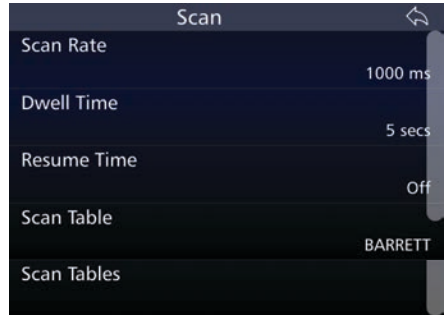

Scan Rate

This defines the rate of which the scanning should be performed.

Select the scan rate applicable to non-Selcall scan channels, either: 300, 500, 700, 1000, 1500, 2000, or 5000 ms.

Dwell Time

Select the length of time the transceiver dwells (waits) on a channel after scan has been stopped by signal strength level (if signal strength level mute is set) or voice activity (if audio mute is set).

Select between 1 and 10 seconds.

Resume Time

Set the time period after which the transceiver will automatically resume scanning from the last operation eg. after a key press or PTT.

Select either: Off, 1, 2, 3, 5, 10, 15, 20, or 30 minutes.

Scan Table

Select the Scan Table to be used when the transceiver is put into scan mode, or if enabled, when scan resume occurs.

There can be up to eight Scan Tables with 30 channels in each.

Note: When scrolling through the Scan Tables to make a selection, only Scan Tables with channels entered will display. If none of the Scan tables have any channel entries, the message "All Scan Tables Empty" displays.

Tap **Table Selection** from the Scan screen to display the Table Selection screen.

To reveal more items, either swipe up on the touch screen or press .

Each entry shows the name of the table and the respective number of channels.

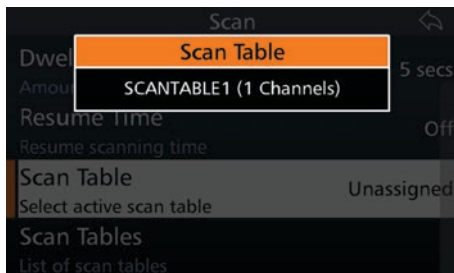

Scan Tables

Note: All channels are displayed in numerical order within the scan table with respect to the entry number. There are a maximum of 30 entries in each table.

Tap **Edit Scan Tables** from the Scan screen to display the Selcall Scan Tables screen.

The example shows two scan tables which may be edited. Each table reveals the name of the table, the antenna, the number of channels in the table and the channel numbers.

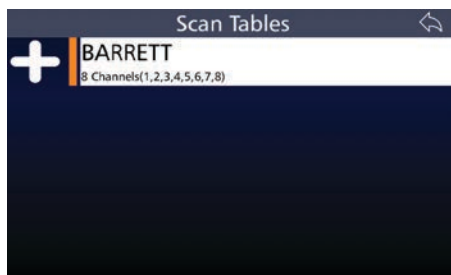

Add a Scan Table

To add a Scan Table, tap  from Scan Settings < Edit Scan Tables.

Scan Table Name

This is the name of the scan table. Without setting this, the name will default to "TABLE".

Scan Table Channels

Tap the checkboxes adjacent to the channels you wish to choose and then tap



After configuring the above items, tap  to add the table.

A confirmation message displays.

Tap **Yes**.

Delete a Scan Table

Select the table to be deleted, then tap and hold for three seconds.

A confirmation message displays.

Tap **Yes**.

Secure Display Mode

This mode hides the display of frequencies on the front panel. Channel frequencies are uneditable, as are labels. The pack and diagnostic information becomes irretrievable and cannot be exported.

This mode can only be enabled or disabled using the Barrett Communications 4000 Series Programming Software.



Security Settings

This section is used to configure the security settings for the transceiver.

Tap **Security** from the **Settings** menu to access the Security menu.

A list of items that may be configured is displayed.

The current status of each of the items is displayed to the right.

This menu is dependant on the Options installed in a transceiver (see page 53).

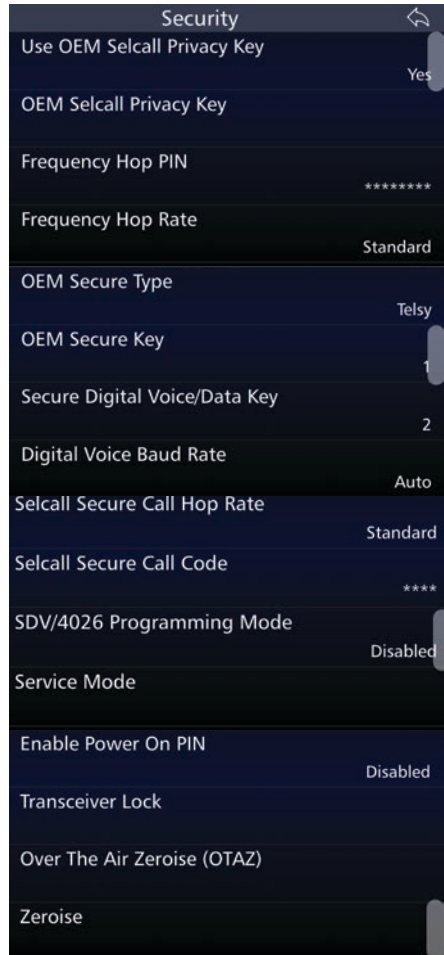

Use OEM Selcall Privacy Key

This setting indicates whether the OEM Selcall Privacy Key is active.

OEM Selcall Privacy Key

Turning this on allows data type Selcalls (Pagecall, GPS, Status, Telcall) on OEM channels to be encrypted with DES-56 encryption.

See page 23 for more information on OEM Selcall.

Frequency Hop PIN

The Hopping PIN (if the Frequency Hopping Option is enabled on the transceiver) is 8 digits long and is usually provided by a network administrator. The Hopping PIN determines the Hop bandwidth. For instance:

Hopping PINs 00000000 to 19999999 are used for hopping ± 2 kHz

Hopping PINs 20000000 to 49999999 are used for hopping ± 16 kHz

Hopping PINs 50000000 to 99999999 are used for hopping ± 128 kHz

Hopping up to ± 2 kHz is useful for narrow band antennas in situations such as antenna tuners in manpack operation.

Hopping up to ± 128 kHz can be used with wideband antennas such as base station broadband antennas.

Please note that all transceivers that wish to communicate via Hopping need to have the same Hopping PIN and frequency hop rate configured.

Note that once entered, the PIN can never be retrieved or viewed for security reasons.

Frequency Hop Rate

The Frequency Hop Rate changes the number of hops per second used by the encrypting algorithm.

Select either Standard (5 hops per second) or High (25 hops per second).

OEM Secure Type

This displays whether a scrambler has been installed and the name of the scrambler.

OEM Secure Key

If keys are installed, keys can be selected from this menu.

Secure Digital Voice/Data Key

The Secure Digital Voice and Data Key is used for secure digital voice and 3G Data calls. Keys need to be entered into the transceiver's SDV module using the Barrett Communications Key Management Software.

Select between 1 and 255.

All transceivers in the network must have the same key number in order to communicate.

For more information, consult the Digital Voice manual (P/N BCM40504).

Digital Voice Baud Rate

The Digital Voice Baud Rate setting fixes the baud rate at 600/700bps, 1200bps, 2400bps or Auto. Setting this rate to Auto will allow the transceiver to automatically adjust the baud rate.

Selcall Secure Call Hop Rate

The Selcall Secure Call Hop Rate is the rate at which the secure call hopping moves between transmission frequencies. Unlike frequency hopping, it doesn't utilise GPS.

Select either Standard (4 hops per second) or High (15 hops per second).

Selcall Secure Call Code

Enter a four-digit number. Both the transmitting and receiving stations must have the same code.

SDV/4026 Programming Mode

If the transceiver is fitted with an SDV module, this option enables the SDV to be programmed.

Select either Disabled or Enabled.

When enabled, the functionality of the transceiver is disabled. After programming the SDV, reboot the transceiver.

For more information, consult the Digital Voice manual (P/N BCM40504).

Service Mode

A mode for use when servicing a transceiver. Only accessible by PIN.

Enable Power On PIN

Selecting this menu option allows a user to manually change whether the transceiver asks for a password upon start-up. This password is set using the Barrett 4000 Series Programming Software.

Transceiver Lock

The Transceiver Lock function locks a remote transceiver via Selcall and uses the remote transceiver's pre-set Transceiver Lock/OTAZ PIN. This function does not remove any settings and can be reversed by entering the Transceiver Lock/OTAZ PIN on the front panel of the transceiver.

Over the Air Zeroise (OTAZ)

OTAZ will clear the following information from a remote transceiver via a Selcall and the entry of the Transceiver Lock/OTAZ PIN for that station:

- all channel information
- all Options
- all ALE 2G and 3G information
- ALL security PINs apart from the Transceiver Lock/OTAZ PIN
- encryption keys

Zeroise

Zeroise will clear the following information from the local transceiver:

- all channel information
- all Options
- all ALE 2G and 3G information
- ALL security PINs apart from the Transceiver Lock/OTAZ PIN
- encryption keys

Remote Access Password

This allows a user to set a password used when accessing the transceiver remotely via serial or network connections e.g. when using the Barrett Remote Control App, the Desktop console or programming via PC.

Stealth Mode

Stealth mode operates as a quiet or silent mode of operation. When active, all transceiver noises are muted, key lights are disabled and the backlight is set to the lowest setting.

To enable stealth mode, tap the icon in the swipe menu.

When active, the icon will be green.

Pressing PTT while stealth mode is active will temporarily deactivate stealth mode, reinstating lights and audio.

Stealth mode will re-activate after 30 seconds of inactivity.

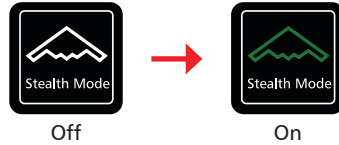
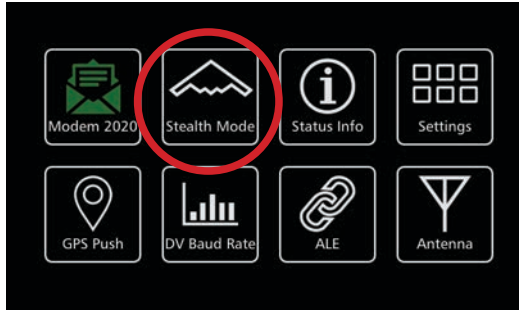

Theme Schedule

The Theme Schedule allows for automatic transition between display themes. This change of themes can be of use for changing, for instance, between a daytime theme and a nighttime theme.

To set a theme schedule, select an alternate theme, the time when the theme will switch on and when it will switch off.

Finally, enable the Theme Schedule by changing the Theme Schedule Status to Enabled.

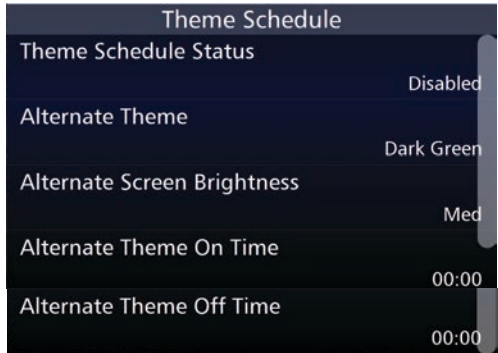

Default



Dark Green



Green



Red

Tuning

When tuning, the transceiver will transmit, at the power level selected, a carrier on the channel selected, at 1.6 kHz above the Suppressed Carrier Frequency (SCF) (displayed frequency) of that channel.



Tune

Tuning occurs automatically when PTT occurs if the appropriate antenna tuner type has been selected. Tuning can also be activated by pressing and holding the tune icon on the front panel.

The keypad will illuminate red whilst the transceiver is tuning.

When the tune process is completed the display will show "Tune Ok", or "Tune Failed" in the top left-hand corner. "No Tuner" will display if the "Base Station Antenna" option is selected.

The VSWR briefly displays below the frequency indicating the efficiency of the selected antenna.



INSTALLATION 7

This chapter contains the following sections:

- Introduction
- Base Station Installations
- Mobile Installations
- Marine installations

Introduction

Most of the installation work can be performed by non-technical personnel if they carefully follow the instructions given in this manual. However, it is recommended that the completed installation be checked by a suitably qualified technician. In some equipment configurations, technical adjustment is required for the equipment to operate correctly.

Note: Some equipment has specific instructions supplied with it. Those instructions over-ride the general guidance of this manual, and must be followed in detail.

For further information on these installations, please consult the guide provided with your antenna or contact your Barrett dealer.

Please note: When unpacking your order, check the contents against the packing notes provided. Before discarding the cartons, check that all accessories have been removed and are not mislaid in the packing material. Inspect the equipment for any transit damage. If damage has occurred, notify your supplier immediately. Failure to do this could affect the warranty covering the equipment.

Base Station Installations

This section provides instructions for the installation of land based HF communication equipment.

Site Selection Recommendations

Site selection and system design go hand in hand and should be considered before any equipment is purchased. The success of every HF Radio system is primarily measured by its ability to receive weak signals and to transmit RF power efficiently. A number of important factors need to be considered to achieve success. These include: frequency selection, time of day and ambient noise at the receiver site. Frequency and time of day are factors which can be used to calculate the maximum usable frequency (MUF) and lowest usable frequency (LUF) using prediction software freely available on the internet. A typical example of this is VOACAP, <http://www.voacap.com/prediction.html>.

Local Area Noise

Forcing the radio system into an unsuitable site will undoubtedly result in disappointing if not unworkable performance of the system. Little can be done to improve an installed system if, for example, the ambient RF noise is unacceptably high.

Ideally, the received signal strength indication (RSSI) in Rx mode should show no more than -100 dB to indicate an acceptably quiet receiver site.

Typically, a noisy site, (beyond suitability) will show a RSSI level greater than -70 dB. As a rule, anything more than -80 dB would be of concern.

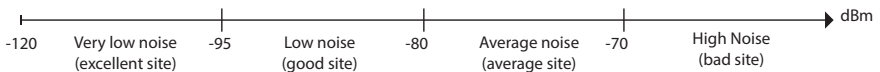

It is recommended that site evaluation be done before any system designs are finalised to avoid system performance disappointment.

The following should be considered when choosing a position for the transceiver:

Operating Convenience

The transceiver should be placed so that the operator is comfortable and any required facilities are easily accessible.

Air Circulation

The 4050 relies on air flow around cooling fins to dissipate heat generated by the transmitter. The mounting position must allow free air flow around these fins.

Proximity of Transceiver to Antenna

When using RG-58 coaxial cable from the transceiver to the antenna, a cable length of no more than 30 metres is recommended. Should a run of more than 30 metres be required, it is recommended that a low loss coax such as RG-213 or RG-8 be used.

It is recommended that the transceiver chassis is connected to ground (earth) using the post on the rear panel to stop pick-up of unwanted noise from local power supplies and electrical equipment.

Power Supply

When either a 12 or 24 V DC is supplied to the 4050 transceiver, the PEP Voice output power will achieve 150 W.

Power output regulation is performed automatically based on the DC voltage presented to the transceiver DC input connector. The Barrett 4022 Power Supply is available in the BC402201 (24 V DC) version. This power supply version is capable of operation with AC mains input voltage between 88 and 256 V AC.

In base station installations where no mains supply is available, various Barrett solar power supply solutions are available depending on the system configuration requirement.

Note: Some installations use an AC battery charger to float charge the supply battery. Battery chargers can produce electrical noise from the rectifier diodes. This noise causes a static type of interference in the receiver. It may be necessary, therefore, to switch off the battery charger whilst the transceiver is in use. If float charging of batteries is required for installations with unreliable AC power supply, it is recommended that BC402201 be used as it provides a three stage charge facility to maintain a battery without the noise problem described above.

Connection Details for a 4050 Transceiver with a Battery Backup Using the 4022 Power Supply

For further information regarding the Barrett 4022 Power Supply, refer to the 4022 Power Supply / Charger Operating Manual (P/N BCM402200).

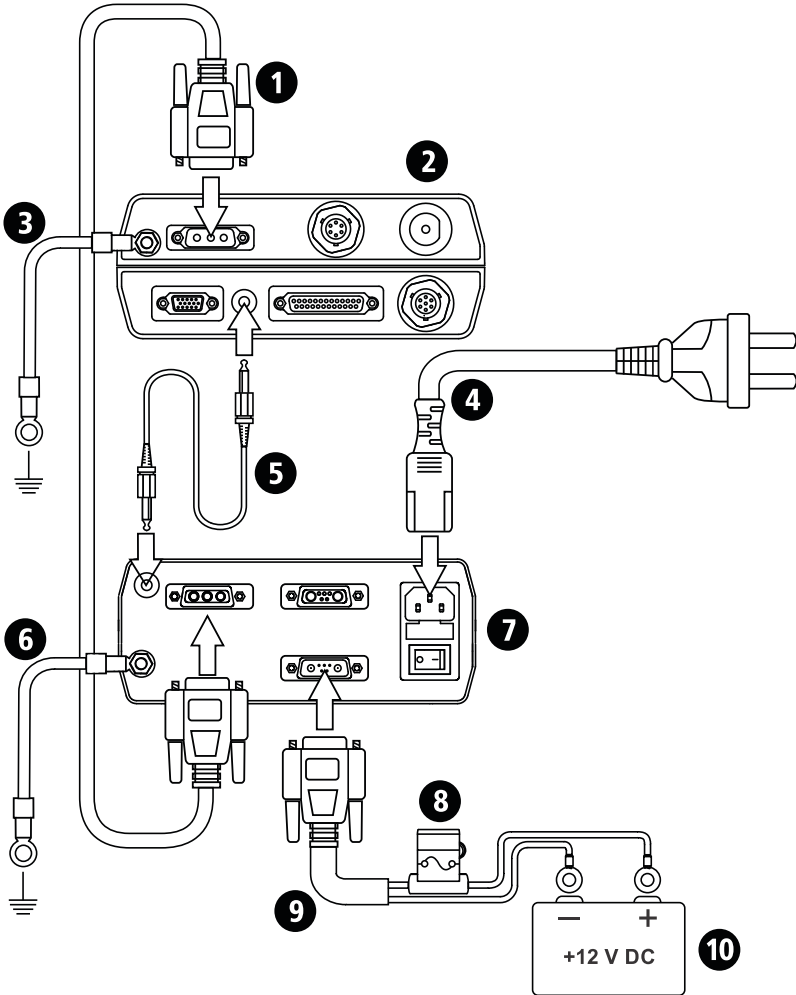

- 1 4050 transceiver to 4022 Power Supply Cable (P/N SA-42020)
- 2 Barrett 4050 HF SDR Transceiver (P/N BC405000)
- 3 Ground (earth)
- 4 IEC mains cord (P/N SA-00020)
- 5 Speaker cable (P/N SA-45010)
- 6 Ground (earth)
- 7 Barrett 4022 Power Supply (P/N BC402201)
- 8 In-line Fuse
- 9 3 metre battery back-up cable for 4022 Power Supply (P/N BCA402201)
- 10 12 V Sealed Lead Acid Battery (P/N BCA92203)

Voltage Drop

The average current consumption of the transceiver is low but during transmission of voice peaks, high current is needed for short intervals. This means that the power supply cable must be heavy enough to supply these short duration current peaks without excessive voltage drop. Preferably, only use the power cable supplied with the transceiver. If extra cable is required, use a cable with a conductor square area of no less than 8 mm². Unwanted voltage drop will also occur if incorrect wiring techniques such as poor choice of connection points and incorrect use of terminal lugs are used.

Protection Fuse

The transceiver is provided with adequate internal protection from over-current or short-circuit. The fitting of an additional external fuse is still considered necessary for both the protection of the transceiver and to ensure that in the event of damage to the cable, a fire does not occur. The fuse used must be installed in the active wire as close as possible to the battery, and must be of a type which has a low voltage drop at the peak currents expected.

Note: In-line 3AG glass fuses are not suitable. An ATC automotive blade type fuse rated at 25 A with a suitable high current ATC fuse holder rated at 30 A or more should be used. These type of fuses and holders are contained in our standard installation kit (P/N BCA40004) or are available individually (P/N BCA20021).

Cooling Fan

The cooling fan is an optional extra which may be added to the 4050 transceiver for situations where high volumes of data or Digital Voice transmissions may cause the transceiver's internal temperature to rise above 65°C.

The cooling fan requires no user input as it is temperature controlled by software, automatically activating when necessary.

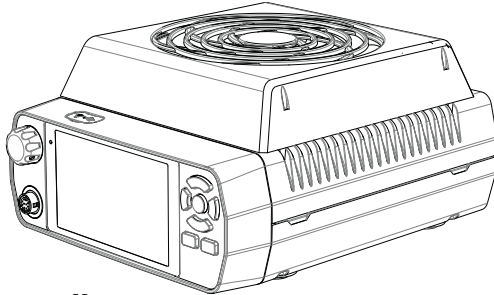

Installing the Cooling Fan

Attach the cooling fan to the transceiver by carefully aligning the connector pins located beneath the cooling fan with the socket on top of the transceiver as shown below.

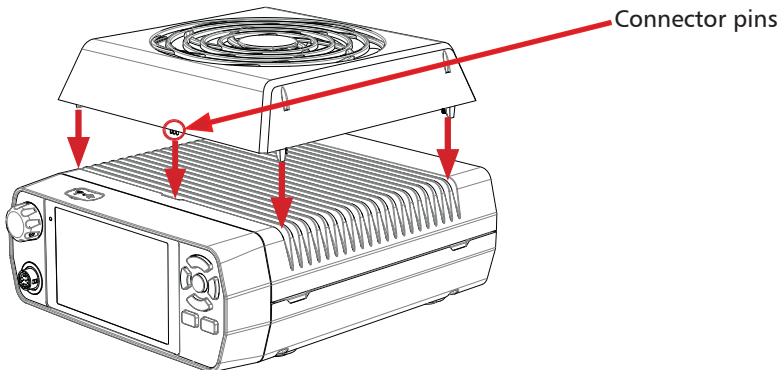

Four screws (located in the four corners of the cooling fan) are used to secure the cooling fan to the transceiver.

To uninstall the cooling fan, reverse the installation procedure.

Antennas

The antenna is a most critical part of the complete radio installation. It must accept the output power from the transmitter, radiate that power with minimum loss and in the receive mode, accept weak signals for input to the receiver.

Incorrect antenna installations will yield poor system performance and are often the cause of complaints of poor transceiver performance.

A range of antennas is available from Barrett to suit most small fixed stations. Detailed instructions are included with each antenna.

912 Broadband Dipoles

(P/N BC91200 and BC91201)

Barrett 912 broadband dipoles are ideal for base stations that require operation on multiple frequencies throughout the HF spectrum using a single antenna.

Please consult the relevant guide for each 912 base station antenna for further information. These can be downloaded from barrettcomms.com.

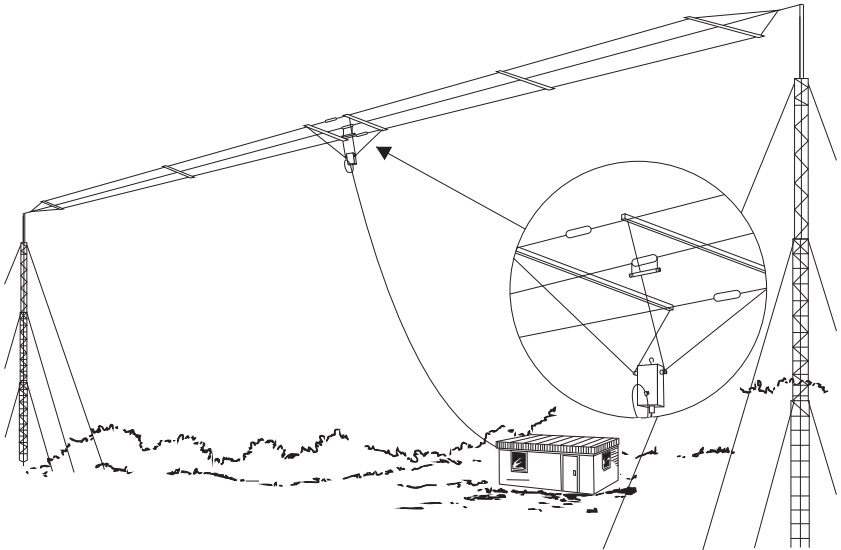

Barrett 912 antennas can be mounted in a horizontal configuration with a 12-15m mast or in an Inverted V configuration with a 10-15m mast.

The required minimum distance between the masts is 32 metres for horizontal configuration.

Halyards and pulleys required to hoist and support the antenna are not supplied, however they can be purchased separately from Barrett Communications (Halyard and Pulley Kit P/N BCA91201). It is recommended that the halyards used to support the antenna be either UV stabilised Dacron cord or wire rope and that pulleys be of stainless steel construction.

For a 10-15m mast with an antenna in inverted V configuration, rods or stakes should be inserted into the ground at least 9m away from the mast in order to secure the antenna ends.

As with all antenna installations, ensure the antenna is as far from sources of electrical interference as possible and in a position that makes it impossible for the antenna to come in contact with high voltage overhead mains wiring.

It is highly recommended that antennas be installed by suitably qualified personnel.

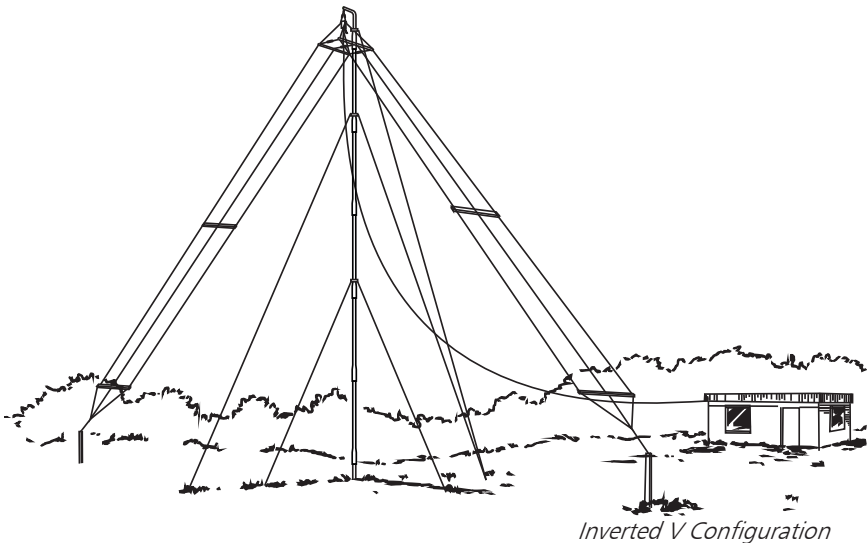

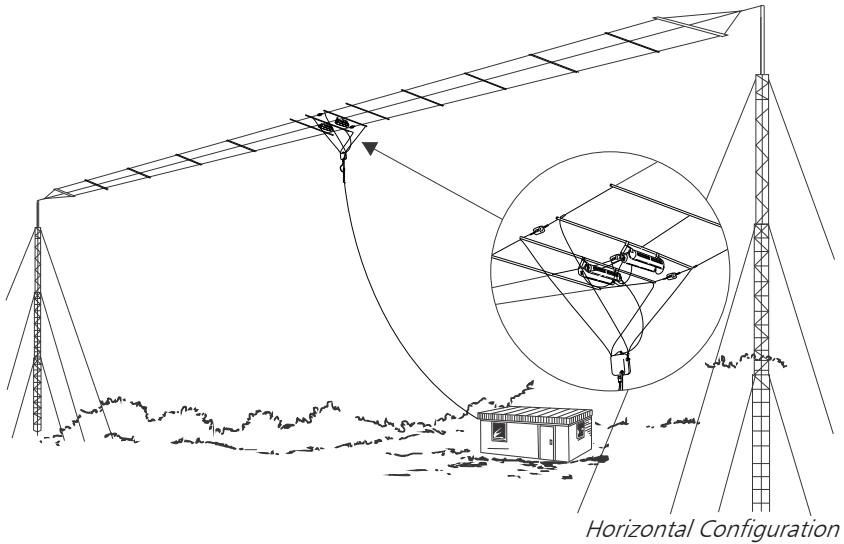

4017 Automatic Tuning Horizontal Dipole Antenna

The Barrett 4017 Automatic Tuning Horizontal Dipole Antenna is designed for conditions where area is limited but a high performance base station antenna is still required. It consists of composite radiation elements driven by an automatic antenna tuner to allow operation from 3 to 30 MHz. The tuner provides broadband impedance matching during scan mode (receive) operation, for reliable link establishment using modern radio protocols.

The antenna is designed for operation on a 6 to 10 metre standard 50 mm mast making it simple to install. With a packed length of 2.1 metres the antenna can be easily transported by air.

Assembly fixtures are supplied to assist in mounting the antenna to an existing mast, tower or pole. Alternatively, a range of suitable masts can be supplied with the antenna.

The tuner has a memory system that stores tuning information for each channel after an initial tune sequence with unlimited capacity.

For further information regarding the 4017 Automatic Tuning Horizontal Dipole Antenna, please consult the 4017 Automatic Tuning Horizontal Dipole Antenna User Manual (P/N BCM401700).

Connection Details for a 4050 Transceiver and 4017 Automatic Tuning Horizontal Dipole Antenna

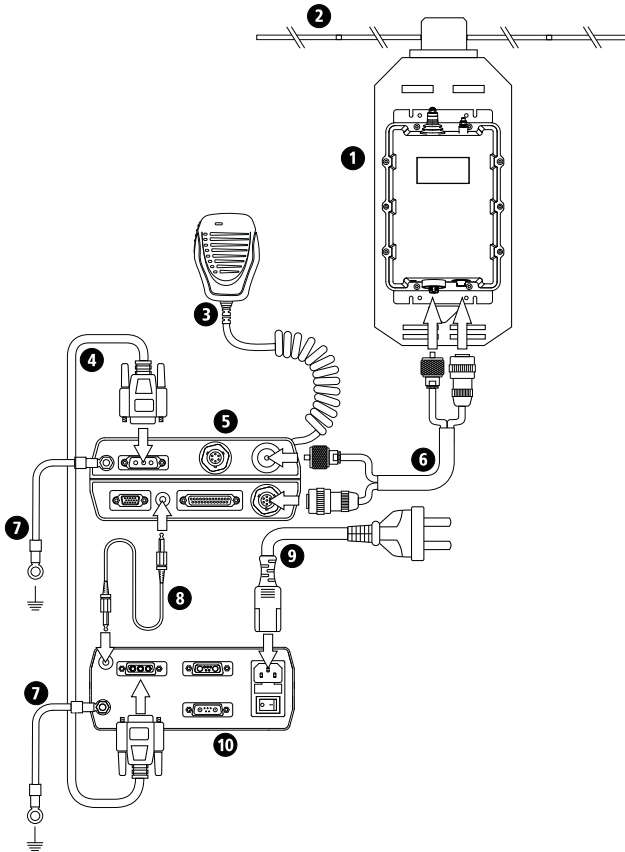

- 1** Barrett 4017 Automatic Tuning Horizontal Dipole Antenna (P/N BC401701)
- 2** Horizontal Dipoles and Mounting Assembly
- 3** Microphone (P/N MI-45001)
- 4** Power cable 4022 to 4050 (P/N SA-42020)
- 5** Barrett 4050 HF SDR Transceiver (P/N BC405000)

- 6 Coaxial / Control Cable (P/N 4017-01-01)
- 7 Ground (earth)
- 8 Speaker cable (P/N SA-45010)
- 9 IEC Mains cord (P/N SA-00020)
- 10 Barrett 4022 24V Power Supply (P/N BC402200)

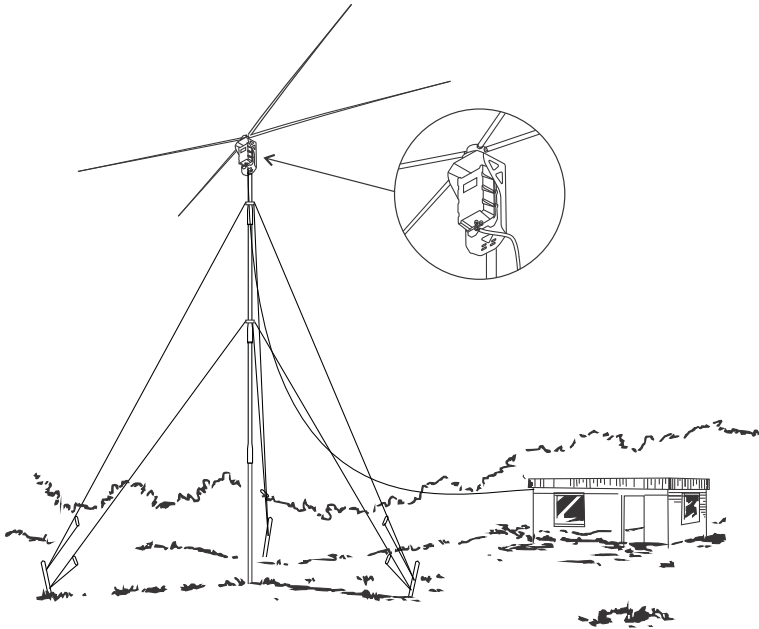

4011 Automatic Antenna Tuner for Base Station Installations

Antennas such as long-wires, vertical whips and loop configurations require an Antenna Tuning Unit to operate correctly.

Housed in a fully weatherproof enclosure, the 4011 will tune long wire antennas effectively up to a length of 10 metres and wire loop antennas or whip antennas over a frequency range of 2 to 30 MHz. Tuning is rapid, typically less than one second the first time RF is applied, either whilst the operator is talking or when the "Tune" control is activated on the transceiver (see page 98).

The 4011 tuner features a memory facility that stores the configuration required to tune to a frequency. On any subsequent use of that frequency, the 4011 reconfigures to the stored settings in typically less than 130 milliseconds. Following initial tuning, the antenna's VSWR is monitored. If any significant variation occurs, the 4011 will re-tune the antenna automatically.

The 4011 is supplied complete with coaxial / control cable having an overall length of 30 metres (P/N 4017-01-01). The cable is a composite design incorporating coaxial, power supply and control cables.

For further information regarding the 4011 Automatic Antenna Tuner, please consult the 4011 Automatic Antenna Tuner User Manual (P/N BCM401100).

Antenna

The following points should be considered when mounting an antenna with the 4011:

- The antenna should be mounted as far away as possible from buildings, trees, vegetation and sources of electrical interference. If metallic masts or supports are used, arrange insulators to ensure the antenna is spaced at least two metres from the mast.
- The radiating part of the antenna starts at the tuner. The base of the antenna should be centrally located as per above criteria.
- High voltages are present on the antenna system. The antenna tuner and antenna should be located or protected so that there is no possibility of accidental contact or danger of RF burns.

Transceiver and Tuner Mounting

The transceiver should be mounted in a suitable position allowing easy operator access. The antenna tuner should be mounted, preferably out of the weather, and as close to the ground (earth) point as possible. The interconnect cable supplied with the antenna tuner should be routed, away from other cables, back to the transceiver and connected as indicated in the diagram. The maximum interconnect cable should be less than 25 metres.

Ground (Earth) System

The ground (earth) system is a key part of the overall antenna system and consequently the system operation. An inadequate ground (earth) system is the primary cause of poor performance and tuning problems. Unless a good ground (earth) system (counterpoise) can be provided, there is little point in installing the antenna. In areas of good ground (earth) conductivity (i.e. the terrain is always damp), an effective ground (earth) can be made through a grounding (earthing) rod. This should be a minimum 1.5 metres in length and should be installed as close to the tuner as possible. A suitable grounding (earthing) kit can be purchased from Barrett Communications (P/N BCA90056). Several rods bonded together will improve the ground (earth) contact. In some cases metal water pipes may be used as a ground (earth) providing:

- The water pipe is close to the tuner and the water pipe enters the ground close to the tuner.
- There are no joints or couplings in the pipe that will increase the resistance path to ground.
- The water pipe enters soil with good conductivity.
- A low resistance joint is made with the water pipe.

Frequently the ground (earth) conductivity will not be sufficient to provide a satisfactory ground (earth) for the Barrett 4011 ATU. This will almost certainly be the case in well drained sandy soils or on rock. In these cases, a counterpoise must be used as a ground (earth) system. This will also be the case in rooftop installations where no existing ground plate (such as metal roofing) exists.

The number of radials required for an effective counterpoise depends on the soil quality, dampness and other factors which affect the conductivity of the soil. The more radials used, the better the performance of the antenna/ATU combination especially at lower frequencies. This manual suggests a minimum of 20 radials, but optimum performance at low frequencies is not guaranteed.

The radials of the counterpoise need only be of much thinner cable i.e. 5.48mm² (#1 #2 SWG) preferably copper wire. RG58 Coaxial cable may be used. At the base of the antenna, the radials all couple together at a common well bonded antenna ground (earth) point. The radials should be buried into the ground to a minimum of 200 mm depth.

Note: To accomplish reliable ATU tunes at frequencies below 5 MHz, it is not uncommon, with poor conductive soil conditions, to require up to 120 radials each of up to 70 m length, requiring thousands of metres of cable and a lot of trenching. This is impractical and is the reason Whip/ATU antennas are NOT recommended for land based systems.

Post-Installation Performance Test

After the mechanical installation of the system is complete as per the system diagram:

1. Select the highest frequency to be used on the transceiver.
2. A directional wattmeter should be inserted into the coaxial transmission line between the transceiver and the tuner. If one is not available, the internal metering of the Barrett 4050 Transceiver could be used for this test.
3. Press the TUNE button on the transceiver front panel to begin a tune cycle. This will key the system with modulation and the exciter will provide a low RF level to the tuner for the period of the tune cycle. On detection of this RF energy, the tuner should start to tune, indicated by the 'clattering' of the tuner relays. After a few seconds the relay noise will cease, the transceiver should indicate "Tune OK" and the watt-meter and 4050 front panel should show a low value of reflected power, consistent with a VSWR of better than 2:1.
4. Select the lowest desired frequency on the transceiver and repeat the above procedure. The result should be the same, except that the tune cycle may take somewhat longer.

If the above procedure does not give the results indicated, check that the antenna length and connections are correct and re-check all ground connections. If a successful tune is achieved, the exciter will raise the excitation power to achieve the full output power from the system.

Note: When shipped, the Barrett 4011 automatic tuning antenna memory system will not have any pre-stored tuning information appropriate to your installation. To allow the 4011 to 'learn' its tuning information, simply proceed from one channel to the next allowing the normal tune cycle to take place. Each successful tune is 'memorised' so that when that channel is re-selected the tuner will almost instantaneously retune to that frequency.

Connection Details for a 4050 Transceiver and 4011 Automatic Antenna Tuner in a Base Station Configuration

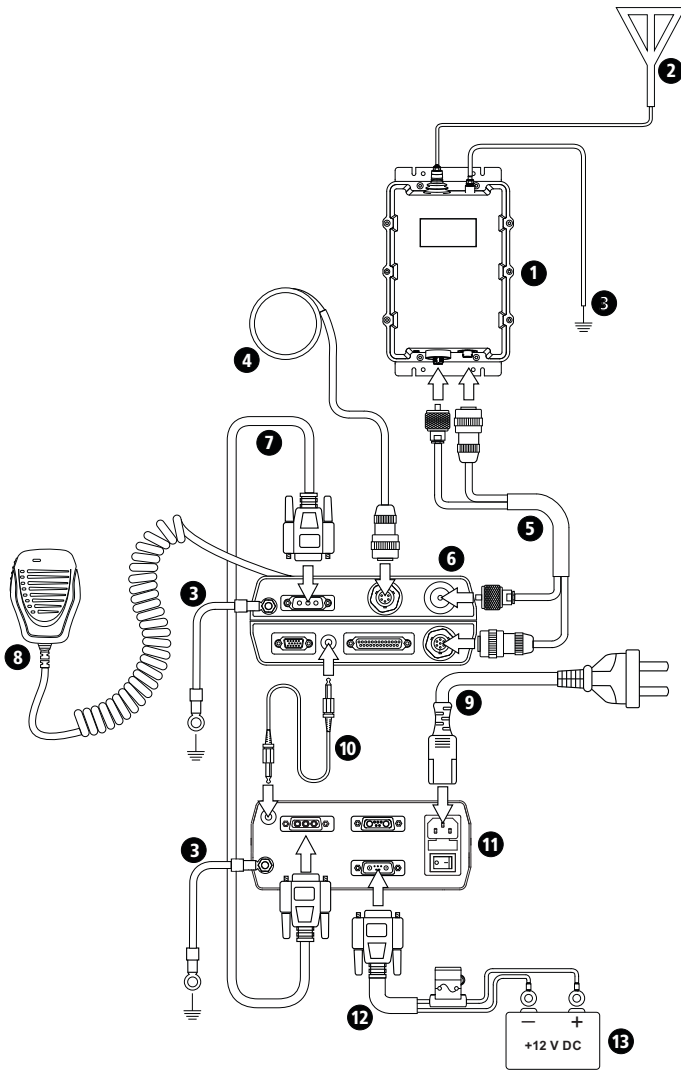

- 1 Barrett 4011 Automatic Antenna Tuner (P/N BC401101)
- 2 Horizontal dipoles and mounting assembly
- 3 Ground (counterpoise)
- 4 External GPS receiver option (P/N BCA40009)
- 5 Coaxial / Control Cable (P/N 4017-01-01)
- 6 Barrett 4050 HF SDR Transceiver (P/N BC405000)
- 7 Microphone (P/N MI-45001)
- 8 Ground (earth)
- 9 IEC mains cord (P/N SA-00020)
- 10 Speaker cable (P/N SA-45010)
- 11 Ground (earth)
- 12 Barrett 4022 Power Supply (P/N BC402201)
- 13 Battery backup cable 3m (P/N BCA402201)
- 14 12 V Battery (P/N BCA92203)

911 Automatic Antenna Tuner for Base Station Installations

The Barrett 911 Automatic Antenna Tuner is designed for use in land base station and maritime HF services. Primarily designed for operation with end-fed unbalanced antennas such as whips and long wires, the tuner is built in a waterproof impact resistant, moulded ABS plastic enclosure.

Antenna

Various antenna configurations, such as vertical whips, long-wires and loops can be used for base station installations using the Barrett 911 Automatic Antenna Tuner.

In general however, the following points should be considered:-

1. The antenna should be mounted as far away as possible from buildings, trees, vegetation and sources of electrical interference. If metallic masts or supports are used arrange insulators to ensure the antenna is spaced at least 2 metres from the mast.
2. Remember the radiating part of the antenna starts at the tuner. The location of the bottom portion of the antenna is very important.
3. Horizontal wire antennas have maximum radiation broadside to the antenna when the frequency is less than $1/4$ wavelength. Radiation is at a minimum at the end points of the antenna.
4. Inverted "V" installation of horizontal antennas minimises the directivity and is recommended for omni-directional coverage.
5. High voltages are present on the antenna system. The antenna tuner and antenna should be located or protected so that there is no possibility of accidental contact.

Transceiver and Tuner Mounting

The transceiver should be mounted in a suitable position allowing easy operator access. The antenna tuner should be mounted, preferably out of the weather and as close to the ground (earth) point as possible. The interconnect cable supplied with the antenna tuner should be routed back to the transceiver (away from other cables) and connected as indicated in the diagram.

Ground (Earth) System

The ground (earth) system is a key part of the overall antenna system and consequently the system operation. An inadequate ground (earth) system is the primary cause of poor performance and tuning problems. Unless a good ground (earth) system (counterpoise) can be provided, there is little point in installing the antenna. In areas of good ground (earth) conductivity (ie. the terrain is always damp) an effective ground (earth) can be made through a grounding (earthing) rod. This should be minimum 1.5 metres in length and should be installed as close to the tuner as possible. A suitable grounding (earthing) kit can be purchased from Barrett Communications (P/N BCA90056). Several rods bonded together will improve the ground (earth) contact. A least preferred method and one that should be avoided if possible is to use existing metal water pipes as a ground (earth) providing:-

1. The water pipe is close to the tuner and the water pipe enters the ground close to the tuner.
2. There are no joints or couplings in the pipe that will increase the resistance path to ground.
3. The water pipe enters soil with good conductivity.
4. A low resistance joint is made with the water pipe.

Frequently the ground (earth) conductivity will not be sufficient to provide a satisfactory ground (earth) for the Barrett 911 Tuner. This will almost certainly be the case in well drained sandy soils or on rock. In these cases a counterpoise must be used as a ground (earth) system. This will also be the case in roof-top installations where no existing ground (earth) plate (such as metal roofing) exists. The radials of the counterpoise need only be of much thinner cable i.e. 5.48mm^2 (#1 #2 SWG) preferably copper wire. RG58 Coaxial cable may be used. If radial wires are used the counterpoise should consist of at least 8 to 10 radial wires. When radials or mesh are used at ground level it is recommended that they be buried a minimum of 200mm below the surface.

Post-Installation Performance Test

After the mechanical installation of the system is complete as per the system diagram:

1. Select the highest frequency to be used on the transceiver.
2. A directional wattmeter should be inserted into the coaxial transmission line between the transceiver and the tuner. If one is not available, the

internal metering of the Barrett 4050 Transceiver could be used for this test.

3. Press the TUNE button on the transceiver front panel to begin a tune cycle. This will key the system with modulation and the exciter will provide a low RF level to the tuner for the period of the tune cycle. On detection of this RF energy, the tuner should start to tune, indicated by the 'clattering' of the tuner relays. After a few seconds the relay noise will cease, the transceiver should indicate "Tune OK" and the watt-meter and 4050 front panel should show a low value of reflected power, consistent with a VSWR of better than 2:1.
4. Select the lowest desired frequency on the transceiver and repeat the above procedure. The result should be the same, except that the tune cycle may take somewhat longer.

If the above procedure does not give the results indicated, check that the antenna length and connections are correct and re-check all ground connections. If a successful tune is achieved, the exciter will raise the excitation power to achieve the full output power from the system.

Note: When received the Barrett 911 Automatic Antenna Tuner memory system will not have any pre-stored tuning information appropriate to your installation. To allow the 911 to 'learn' its tuning information simply proceed from one channel to the next allowing the normal tune cycle to take place. Each successful tune is 'memorised' so that when that channel is re-selected the tuner will almost instantaneously re-tune to that frequency.

Connection Details for a 4050 Transceiver and 911 Automatic Antenna Tuner in a Base Station Configuration

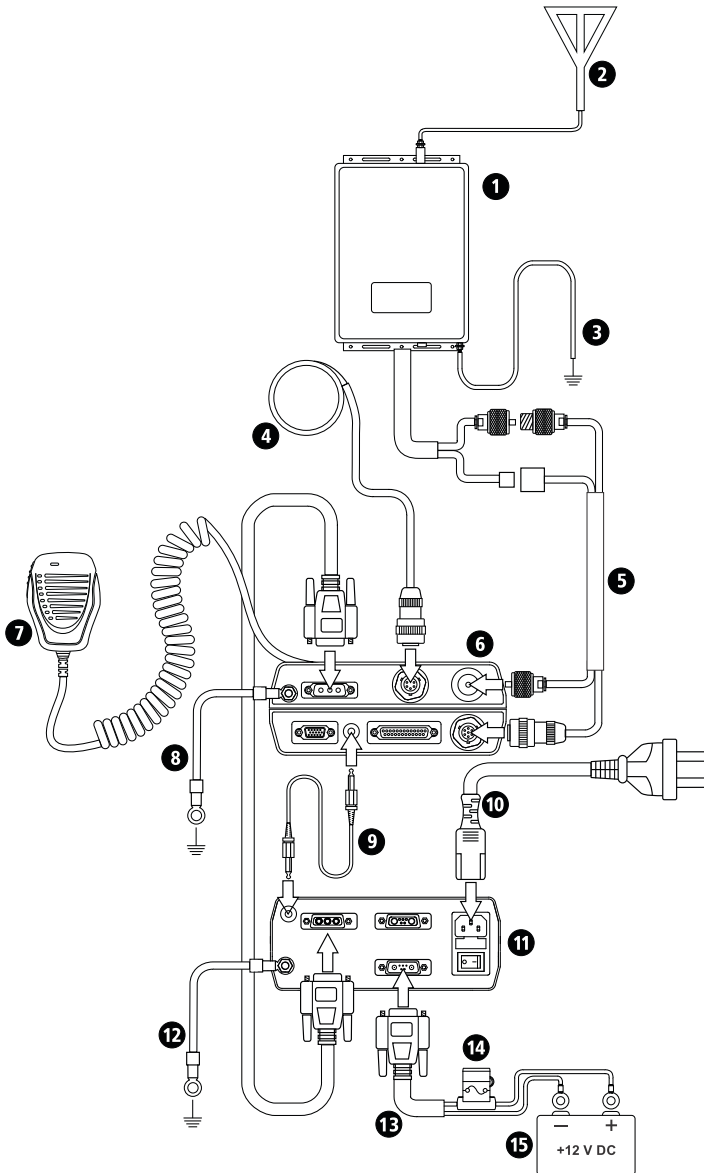

- 1 Barrett 911 Automatic Antenna Tuner (P/N BC91100)
- 2 Antenna
- 3 Ground (counterpoise)
- 4 External GPS receiver option (P/N BCA40009)
- 5 Coaxial / control cable (P/N BCA90055)
- 6 Barrett 4050 HF SDR Transceiver (P/N BC405000)
- 7 Microphone (P/N MI-45001)
- 8 Ground (earth)
- 9 Speaker cable (P/N SA-45010)
- 10 IEC mains cord (P/N SA-00020)
- 11 4022 Power Supply (P/N BC402201)
- 12 Ground (earth)
- 13 Battery backup cable 3m (P/N BCA402201)
- 14 In-line fuse
- 15 12V DC external battery

Mobile Installations

This section describes how to change the 4050 transceiver from a desktop unit (as supplied) to a remote control (trunk mount) unit using the Mobile Pack P/N BCA40501.

Mobile Pack

	<p>Barrett installation kit</p>	<p>BCA40004</p>
	<p>Universal mounting cradle</p>	<p>SA-45060</p>
	<p>Screws and capstans</p>	<p>MW-45027</p>
	<p>RAM Mount</p>	<p>PW-33334</p>

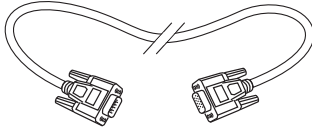

Six metre control head cable with DB-15 connectors

SA-45100

Removing the 4050 Primary Control Head

To install the mobile pack, complete the following steps:

1. Invert the transceiver and use a Posidrive #2 screwdriver to loosen (but not remove), the two front panel securing screws located immediately behind the front panel.
2. Gently pull the front panel from the transceiver to remove it.
3. Fit the supplied capstans to the four holes as indicated.

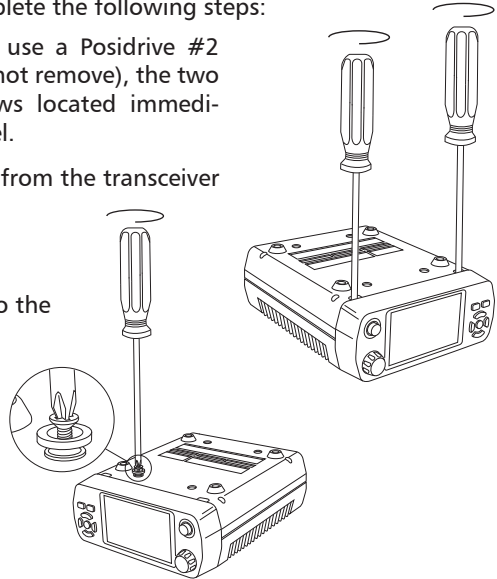

4050 Control Head - Rear View

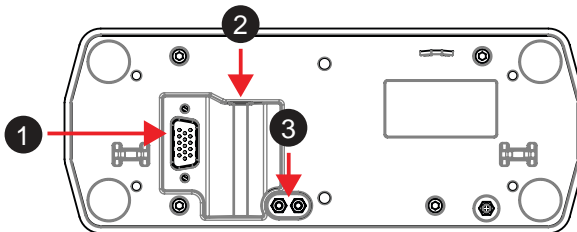

- 1 15-way transceiver plug for remote front panel interface cable
- 2 Speaker jack
- 3 Stand-offs (supplied) to enable the front panel to be detached and a control head cable to be secured in position.

Installing the Mobile Pack

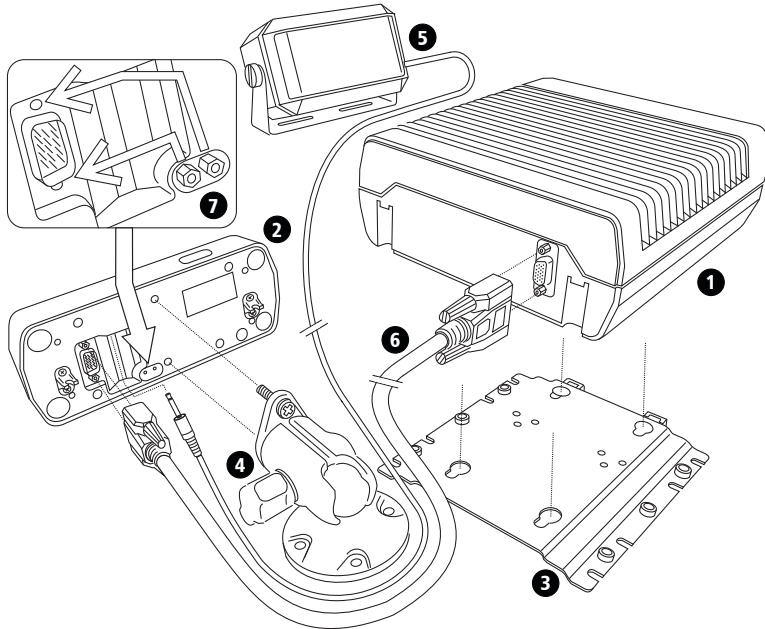

1. Attach the universal mounting cradle **3** to the desired location using the fixings provided.
2. Align the transceiver's capstans into the key holes on the universal mounting cradle and slide to secure it.
3. Attach the RAM Mount **4** to the desired location and affix the front panel to it using the two screws provided.
4. Plug the six metre control head cable **6** into the socket located at the front of the transceiver and secure using the strain relief screws.
5. Remove the two stand-offs **7** from their storage location as indicated and fit securely in position above and below the control head connector.
CAUTION: Do not over tighten.
6. Plug the other end of the six metre control head cable into the rear of the front panel **2** and secure using the strain relief screws.
7. Plug the loudspeaker connector into the socket located at the rear of the front panel **5** as indicated below or the audio jack on the back of the transceiver body.

Transceiver Mounting

The following points must be considered when mounting the transceiver.

Safety

It is essential that the transceiver be mounted in a place where it cannot cause injury to the occupants of the vehicle in the event of a motor vehicle accident. For this reason overhead mounting is not generally recommended and "under dash" mounting must take into account the possibility of injuring the legs of front seat occupants.

Convenience

The chosen position for the transceiver or control head, (if in mobile configuration) should be one which allows convenient operation.

Positions which are often used are:

On the centre console

In place of the glove box

Behind the seat

Under the seat

Under the dash board (if safe).

In a mobile configuration, only the control head needs to be mounted in a position convenient to the operator. The transceiver may be mounted under a seat, in the luggage compartment or any other appropriate place within the vehicle (which allows for sufficient air flow).

All equipment should be positioned in such a way that convenient access for maintenance is provided.

Strength

It must be assumed that the vehicle will be used on rough roads and in many cases off road. Hence, the mounting of equipment must take into account the severe vibration and shock that may be encountered.

Transceivers may only be mounted to structural components of the vehicle body and not on interior panels. In some cases, the area around the transceiver mounting may need reinforcement.

Precautions should be taken to ensure fixing screws etc. cannot vibrate loose.

Air Circulation

The 4050 relies on air flow around cooling fins to dissipate heat generated by the transmitter. The mounting position must allow free airflow around these fins.

Obstruction

The installation of a transceiver into a vehicle should not inhibit the normal use of the vehicle. Before selecting equipment positions, check that normal operation of steering, foot pedals, gear change, hand brake etc. are not impeded, and that heater or air-conditioning outlets, glove box and doors are not obstructed. Always check that the drilling of mounting screw holes will not damage electrical wiring, heater hoses or hydraulic lines.

Power Wiring

Connect the red positive and black negative wires from the transceiver power cable to the positive and negative terminal of the battery. Do not connect to the ignition switch or internal fuse panels as vehicle wiring to these points is of insufficient current capacity, causing voltage drop, possible noise interference and damage to cables through overheating. To prevent this, consider the following:

- Route the power cable away from high tension ignition wiring.
- Secure the power cable, either to other wiring or the vehicle body, with suitable cable ties.
- Where wiring passes through bulkheads, provide appropriate protection to prevent insulation being damaged.
- If an isolation switch is fitted between the battery's negative terminal and the vehicle chassis then it is important to connect the radio's negative supply cable to the chassis side of the isolation switch.

Grounding

Ideally the radio should be mounted as close as possible to the antenna with a common grounding (earth) point being used for both the antenna's ground (earth) connection and the radio's ground (earth) connection. See page 133, page 117 and page 142 for additional information regarding appropriate antenna grounding (earthing).

Antenna Mounting

The antenna mounting must provide a strong secure anchorage for the base of the antenna. To obtain maximum radiation, the antenna base must be well bonded electrically to the vehicle chassis. Paint, dirt, rust, etc. should be removed from the respective fixing points. The mounting point must provide a low resistance electrical path to the main vehicle metallic structure.

Due of the need to reduce the size of HF antennas so that they can be fitted to a vehicle, mobile antenna bandwidth becomes quite narrow and hence tuning is critical. In most cases the only tuning adjustment that can be affected is adjustment to position. Particular attention must be given to the antenna position if satisfactory performance is to be obtained. Refer to the instructions supplied with the antenna you have selected.

Antenna Feed Cables

Antenna feed cables should be run (as far as possible) away from other vehicle wiring and especially away from ignition high tension wiring. Where passing through body panels or internal bulkheads, grommets must be used to protect the cables. Water-proof connectors must be used when they are outside the vehicle.

Voltage Standing Wave Ratio (VSWR)

After installation it is recommended that the VSWR of the antenna should be measured for each channel. The instructions supplied with each antenna will detail this operation.

Noise Suppression

Noise generated by motor or electrical accessories on the vehicle may cause objectionable interference to the received signal. This noise enters the receiver either by means of the battery leads or the antenna system. Providing that the recommendations concerning battery wiring given earlier in this manual are followed, noise injected via the battery lead is unlikely to be significant. Most noise problems result from pick-up by the antenna. Practical cures involve either preventing the noise from being generated or minimising it from being radiated by the wiring connected to the noise source.

Please note that some newer fuel injected engines emit very strong EMI (Electromagnetic interference) noise levels across the HF radio band, which is near impossible to suppress. For these installations, moving the position of the antenna to another position on the vehicle may reduce the noise effect but full elimination of noise while the engine is running may never be achieved. Please note that this is not unique to the Barrett 4050 transceiver as all transceiver makes will suffer similarly from the effects of this noise under these conditions.

General Noise Suppression Tips

When searching for sources of noise, some of their characteristics can be helpful in identification:

- Petrol engine ignition noise and contact breaker noise is a sharp staccato 'plop' varying with engine speed. It is only with this class of noise that the impulse noise limiter incorporated within some transceivers is effective.
- Noise from other sources generally has a more 'mushy' sound. That from the alternator/generator may only be troublesome over a limited range of engine speed and can also be influenced by the state of charge of the battery.
- The noise from instrument regulators may depend on the battery voltage, the reading of the instrument and the length of time the system has been switched on. For this reason, the search for noise sources must be done thoroughly to prevent noise from apparently reappearing after the installation has been completed.
- Electric motors generate a 'whining' sound. Do not forget to check windscreen wipers, electric fuel pumps, heater and air conditioning fans and other motors which operate only on an intermittent basis.

2019 Automatic Tuning Mobile HF Antenna

(Barrett P/N BC201900)

The Barrett 2019 automatic tuning mobile HF antenna plugs directly into the rear of a 4050 transceiver using the cables supplied.

For further information regarding the 2019 Automatic Tuning Mobile HF Antenna please consult the 2019 Automatic Tuning HF Antenna User Manual (P/N BCM201901).

Connection Details for a 4050 Transceiver with Mobile Pack and 2019 Automatic Tuning Mobile HF Antenna

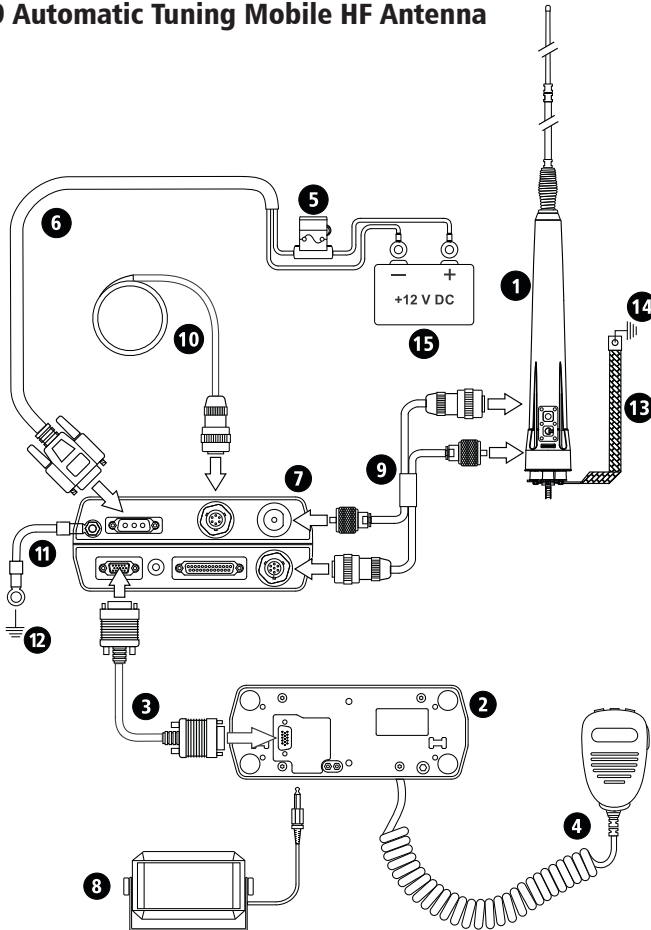

- 1 2019 Automatic Tuning Mobile HF Antenna (P/N BC201900)
- 2 Barrett 4050 HF SDR control head (P/N BCS40005)
- 3 6m Control cable (P/N SA45100)
- 4 Microphone (P/N MI-45001)
- 5 In-line Fuse
- 6 6 metre power cable supplied with transceiver (P/N BCA40006)
- 7 Barrett 4050 HF SDR Transceiver (P/N BC405000)
- 8 Extension speaker supplied with 4050 transceiver (P/N BCA40015)
- 9 Coaxial / control cable extension
- 10 External GPS receiver option (P/N BCA40009)
- 11 Ground (earth) strap between 4050 transceiver and main body of vehicle
- 12 Ground (earth)
- 13 Ground (earth) strap between 2019 ATU and main body of vehicle
- 14 Ground (earth)

Mounting the Barrett 2019 Mobile HF Antenna Tuner

The Barrett 2019 antenna should be mounted in positions similar to those illustrated in the diagrams on the following pages. Select a position free from excessive vibration. A bracket, fabricated to withstand the forces and vibration that can be expected during off-road driving, should be used to mount the antenna to the vehicle. When locating the mounting position for the antenna, ensure that the antenna body, when flexing on its vibration mount, cannot come into contact with other parts of the vehicle. The antenna should be mounted as far from surrounding objects on the vehicle as possible.

The antenna is supplied standard with two sections (Barrett P/N: BCA201901), a tapered black spring (Barrett P/N: BCA201903), an antenna installation guide and a pre-terminated six metre control cable to suit the Barrett 2019 antenna to Transceiver.

The following extension cables for the control cable, are also available:

Extension Cable	Barrett P/N for the 2050	Barrett P/N for the 4050
6 m	BCA201904	2019-00-02
10 m	BCA201905	BCA201905

The control cable should be routed into either the engine compartment or boot (trunk) of the vehicle. If the joint between the antenna control cable and the extension cable is in an exposed position, a rubber self-amalgamating tape should be used to seal the joint. Do not wrap this joint if it cannot be made completely water tight as water will collect in the joint and cause it to corrode.

A good earth (ground) to the main body of the vehicle is essential for efficient operation of the antenna. To achieve this, clean all joints to bare metal and use copper braid earth straps if any non-metallic joints are encountered.

After mounting the main body of the antenna, screw the black base spring onto the antenna body followed by the whip section.

Note: If the antenna is being fitted to a rear door, extra bonding straps should be added from the rear door to the main body / chassis of the vehicle.

Important Information

It is ESSENTIAL to maintain the minimum clearances between the antenna and surrounding metal work as indicated in the diagrams. FAILURE TO MAINTAIN THESE CLEARANCES WILL NOT ONLY REDUCE THE EFFICIENCY OF THE BARRETT 2019 AUTOMATIC TUNING MOBILE HF ANTENNA BUT MAY ALSO LEAD TO INTERNAL RF ARCING AND FAILURE.

Important:

Please note that the mounting of a 2019 antenna on the front of a vehicle may be considered illegal in some areas/countries. Please check with your local transport/vehicle authority prior to installation on the rear of your vehicle.

The overall height of the 2019 antenna once fitted should also be considered.

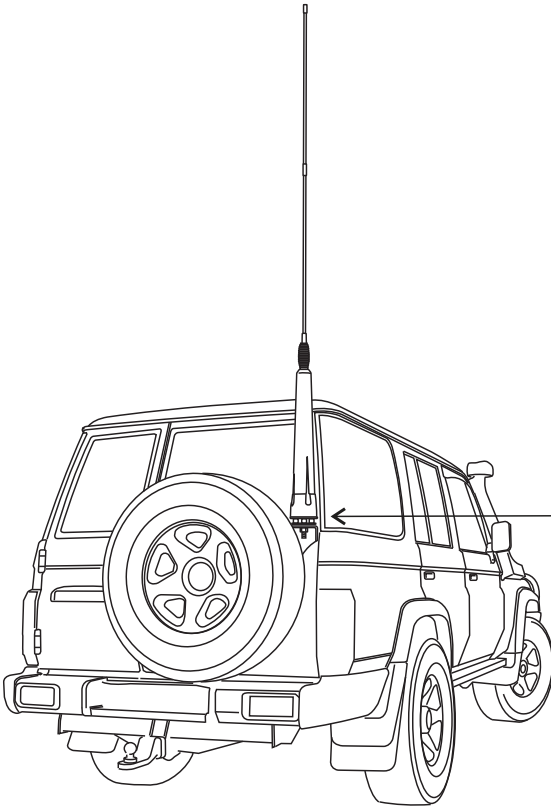

ABSOLUTE MINIMUM CLEARANCE
TOP VIEW

REAR OF VEHICLE

↑160mm

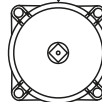

Important:

Please note that the mounting of a 2019 antenna on the front of a vehicle may be considered illegal in some areas/countries. Please check with your local transport/vehicle authority prior to installation on the front of your vehicle.

The overall height of the 2019 antenna once fitted should also be considered.

**ABSOLUTE MINIMUM CLEARANCE
TOP VIEW**

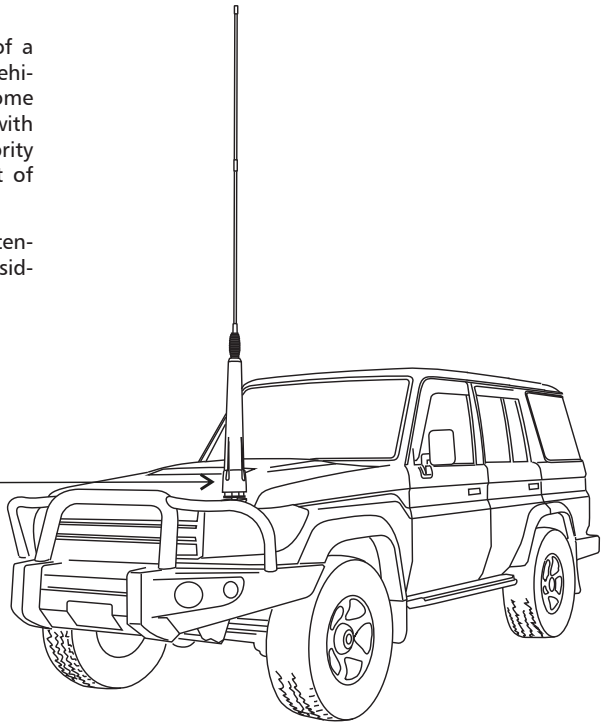
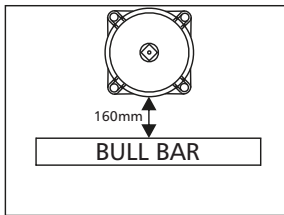

Note: Whilst the 2019 automatic tuning mobile HF antenna is designed to withstand vibration to military specifications on tyred vehicles, some mounting positions on large prime-movers, particularly front mounted bull bars, are subject to vibration that far exceeds this specification. Do not mount the 2019 antenna in positions such as these as damage to the antenna may result.

Grounding (Earthing) the Antenna

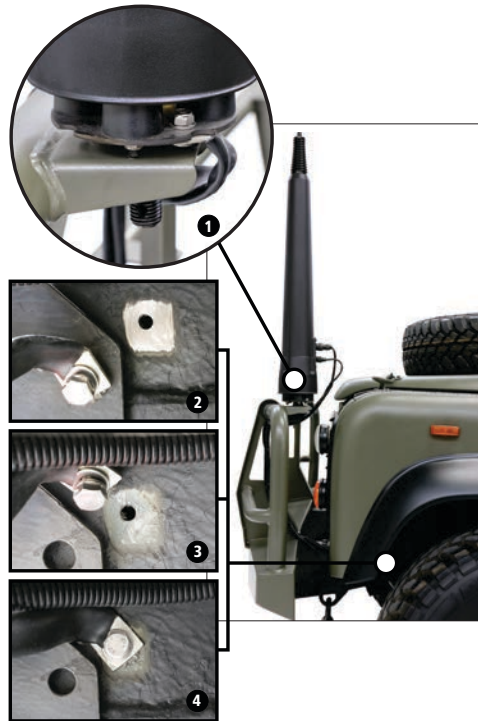

Notes:

- ① Connect an ground (earth) strap to the base of the antenna
- ② Grind away any paint or coating at the grounding (earthing) point on the chassis to expose the bare metal
- ③ Apply electrical contact grease to prevent rust and corrosion and maintain the integrity of the ground (earth) connection
- ④ Attach the ground (earth) strap lug securely with an appropriate fastener.

IMPORTANT: If the antenna is mounted in a high position on the rear door of a vehicle, multiple ground (earth) straps must be used to reach the vehicle chassis's grounding (earthing) point. Ground (earth) conductivity from the antenna to the chassis must be maintained for correct operation of the antenna.

Antenna Assembly

Mounting the Base Spring

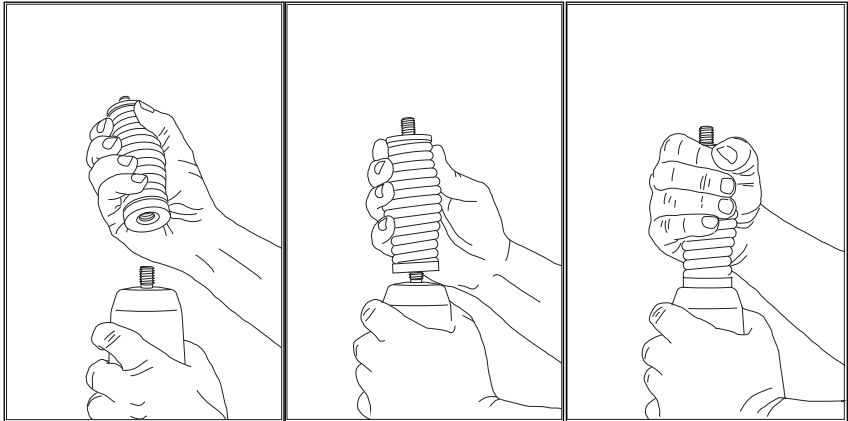

The base spring should only ever be hand tightened, if a tool is used it may damage the spring base.

Mounting the Whip Sections

To mount the whip section it is recommended that only one section of the whip is screwed onto the antenna at a time. The whip section should be hand tightened, then a suitable tool (i.e. a spanner) can be used to tighten the section a further 10 to 20 degrees clockwise while holding the antenna body with a free hand.

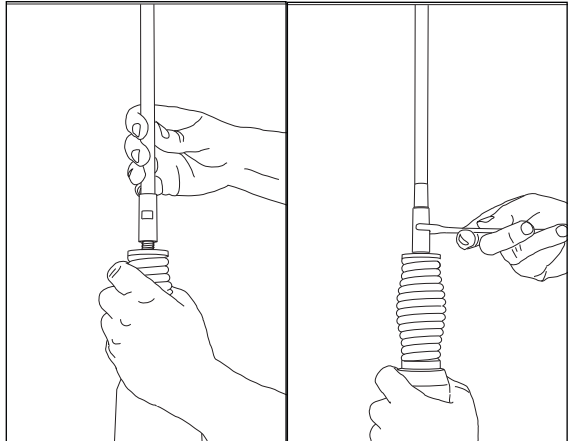

To mount two whip sections together, the unattached whip section should be hand tightened, then a suitable tool (i.e. a spanner) can be used to tighten the section a further 10 to 20 degrees clockwise while holding the already screwed on whip section with a free hand.

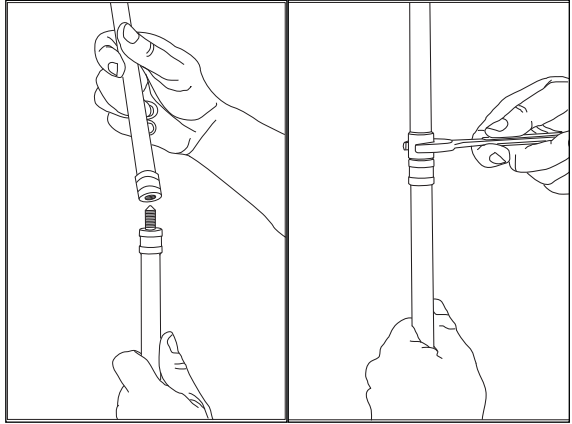

Testing the Barrett 2019 Automatic Tuning Mobile HF Antenna

To test the Barrett 2019 antenna, first select the lowest transmit frequency in the transceiver and tap **Tune**. The display should show the word "Tuning" for a few seconds, followed briefly by "Tune Passed" and an indication of the measured VSWR (Voltage Standing Wave Ratio) value. Check this reading against the VSWR meter.

Repeat the above test on the highest frequency in the transceiver and on a selection of frequencies at approximately 2 MHz intervals. If the tune passes every time, the Barrett 2019 antenna is working correctly. The Barrett 2019 antenna tunes to maximise whip current, not minimise VSWR, but the displayed VSWR value should generally be between 1.0:1 and 2.0:1. However, if the display shows "Autotune Fail" accompanied by low pitched beeps, the Barrett 2019 antenna has failed to tune. Confirm the "Antenna Type" is selected to "2019 Mobile Ant" in the transceiver Settings Menu < IO < Antenna Type setting (page 78). For possible causes check that all cables are properly connected, the earth cable from the base of the Barrett 2019 antenna has a good connection to the vehicle body (not chassis or battery), the whip fitted is not faulty or incorrect and move the vehicle if the Barrett 2019 antenna is close to any metal fences, buildings etc. If the problem cannot be resolved, contact your dealer or Barrett Service Department for advice.

NVIS Kit for 2019 antenna - P/N BCA201910

The Barrett Near Vertical Incidence Skywave (NVIS) antenna whip is designed to enhance the short range communications efficiency of the Barrett 2019 Automatic Tuning Mobile HF Antenna. The increased whip length combined with its horizontal orientation (once installed) provides a significantly higher take off angle and radiation efficiency. Communications paths over the range 20 - 500 kms, particularly in hilly and mountainous terrain, can be greatly improved through the use of the NVIS kit.

The NVIS kit comprises of a single flexible whip section of 4 metres in length which replaces the two section whip (BCA201901) supplied with the Barrett 2019 Antenna. It has fittings at each end to attach to the 2019 antenna and the optional NVIS Kit Magnetic Mounting Base (BCA201911). The whip can also be secured to the vehicle without the magnetic mounting base by using a custom made bracket with a 13mm hole (sourced by end user). This option may be preferable if the vehicle is fitted with a roof rack for example.

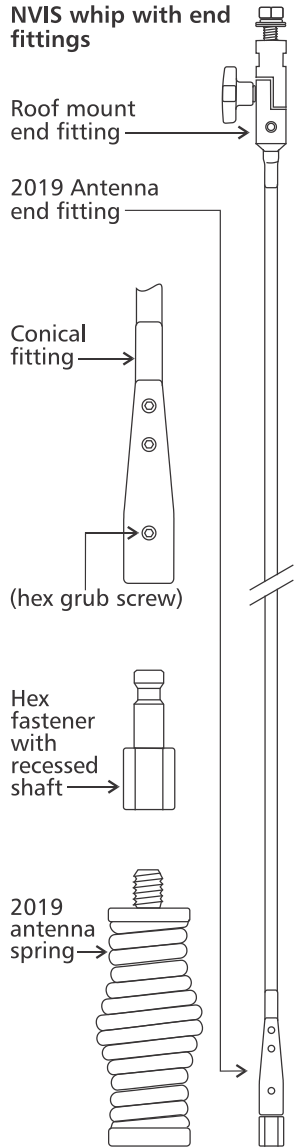

The NVIS kit can be installed as follows:

1. Remove the existing 2019 antenna whip, leaving the spring in place.
2. Unscrew the lowest hex grub screw on the 2019 antenna end of the whip so that the hex fastener with recessed shaft can be removed.
3. Tighten the hex fastener with recessed shaft onto the top threaded stud of the antenna spring with an appropriate tool.
4. Place the conical fitting over the recessed stud and tighten the hex grub screw enough so that the conical fitting can rotate but can not be separated from the recessed shaft. This will allow the conical fitting to rotate while the roof mount end is being attached and also prevent antenna end fitting damaging the vehicle by becoming detached while attaching the roof mount end.
5. Attach the roof mount end of the whip to an appropriate location (see figure 1 as a guide). It could be attached to the optional NVIS kit magnetic mounting base (see figure 3), optional NVIS kit gutter mount bracket (see figure 4) or to a custom fabricated bracket (with 13mm hole). If the magnetic mounting base is used the roof mount end must be locked into one of three angle positions by locating the pin on the surface of one side of the fitting into the hole on the surface of the other side of the fitting (see figure 2). Once the correct angle is achieved tighten the knob firmly by hand.
6. Once the roof mount end is securely in its final position, tighten the hex grub screw that was loosened in step 2.

Figure 1 Example of front and rear antenna mounting using optional Magnetic Mounting Base (P/N BCA201911).

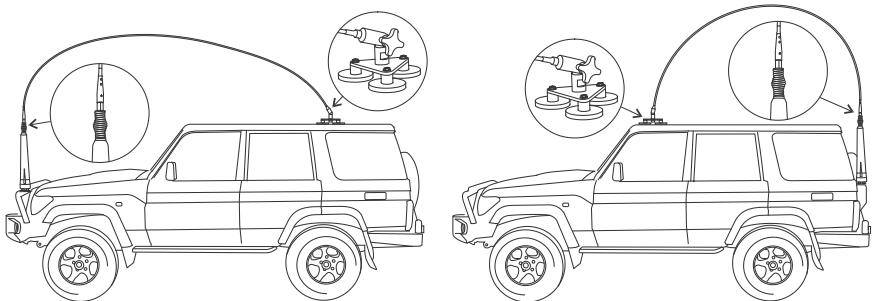

Figure 2

Adjustable roof mount fitting showing locating pin and locating holes.

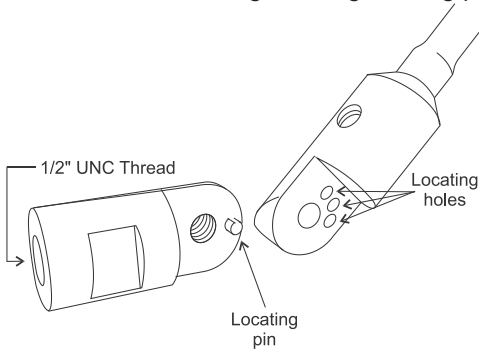

Figure 3

NVIS Kit Magnetic Mounting Base (optional) P/N BCA201911.

Base shown here with roof mount fitting attached.

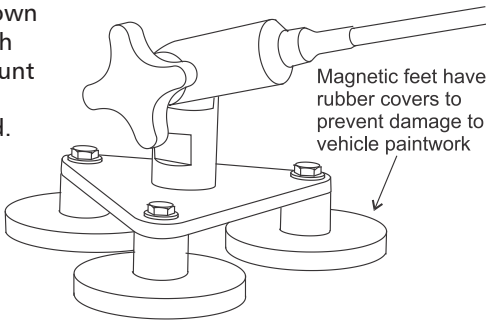
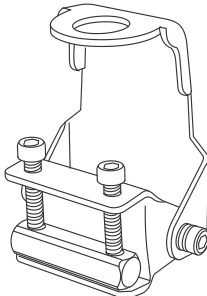

Figure 4

NVIS Kit Gutter Mount Bracket (optional) P/N BCA201912.



2018 Mobile Magnetic Loop Antenna

The roof rack has been designed by Barrett Communications Pty. Ltd. as an integral part of the antenna system. The ground (earth) plate is a heavy-duty aluminium mesh floor, welded to an enclosing frame which maximises current in the radiating loop. The 2018 Barrett Mobile Magnetic Loop Antenna shields and isolates vehicle ignition noise and interference from adjacent power lines providing greater communication clarity.

The 2018 Mobile Magnetic Loop HF Antenna is designed for universal mounting. The roof rack comes in a range of mounting bracket options. Solutions are available that will allow clamping to the roofs of 4WDs, sedans, buses, trucks and prime movers. It is designed to minimise head wind noise with an angled deflector mounted on the front of the unit.

For further information regarding the 2018 Mobile Magnetic Loop Antenna please consult the 2018 Mobile Magnetic HF Loop Antenna User Manual (P/N BCM201800).

Connection Details for a 4050 Transceiver with Mobile Pack and a 2018 Mobile Magnetic Loop Antenna

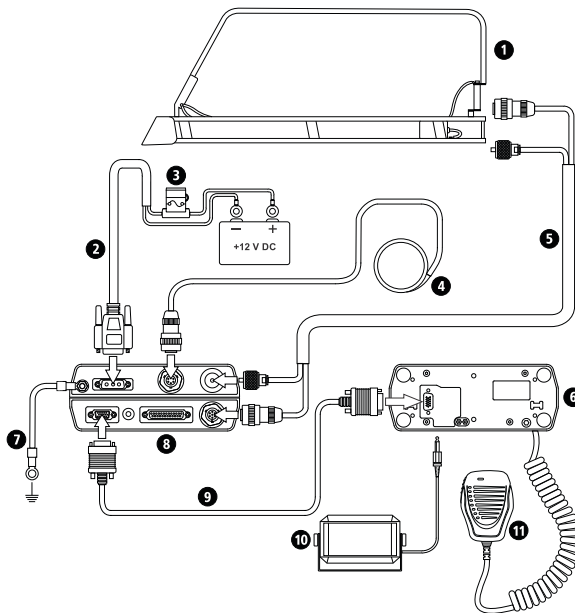

- 1 Mobile Magnetic Loop Antenna (P/N BC201801)
- 2 6 metre power cable supplied with transceiver (P/N BCA40006)
- 3 In-line Fuse
- 4 External GPS Receiver option (P/N BCA40009)
- 5 Control & Coaxial Cable 6m (P/N BCA201904)
- 6 4050 Control Head (P/N BCS40005)
- 7 Ground (earth)
- 8 Barrett 4050 HF SDR Transceiver (P/N BC405000)
- 9 6 m Control Cable (P/N SA 45100)
- 10 Loudspeaker (P/N BCA40015)
- 11 Microphone (P/N MI-45001)

Marine Installations

The Barrett 911 automatic antenna tuner is designed for use in land base station and maritime HF services. Primarily designed for operation with end-fed unbalanced antennas such as whips and long wires, the tuner is built in a waterproof impact resistant, moulded ABS plastic enclosure.

Antenna Selection

The 911 automatic antenna tuner will operate into almost any end-fed antenna with a length exceeding 2.5 metres, providing an effective ground (earth) is used. The antenna efficiency will be proportional to the length of the antenna and will be maximum when the length of the antenna approaches $\frac{1}{4}$ wavelength. It is advisable to limit the wire antenna to $\frac{1}{4}$ or $\frac{3}{4}$ wavelength at the highest frequency to be used.

Antenna

On sailing vessels the antenna can either be an insulated backstay or a whip antenna mounted vertically, usually on the stern. Best performance will be achieved by using an insulated backstay as the radiating length will be longer than that available when using a whip. The top insulator on the backstay should be approximately 300 mm from the mast and the bottom insulator should be at eye level above the deck. The distance between insulators should be greater than 10 metres and less than 35 metres. A whip antenna is generally used on small to medium sized power vessels. There are different length whips to suit the vessel length.

Transceiver and Tuner Mounting

Select a suitable position in the vessel to mount the transceiver. It should be a position that is out of the weather and easily accessible to the operator, whilst as close as practical to the 13.8 V DC power source. Mount the transceiver to a solid fixing point using the mounting cradle. Make sure there is sufficient space at the rear of the transceiver to connect the power and antenna cables.

The antenna tuner should be mounted as close to the antenna feed point as possible. In metal vessels the length of the feeder from the antenna tuner to the feed-through insulator, inside the vessel, should be kept less than 1 metre.

The antenna feed cable should be a suitable high voltage cable. Care should be taken to avoid sharp points when terminating the cable to prevent corona discharges.

The interconnect cable supplied with the antenna tuner should be routed away from other cables back to the transceiver and connected as indicated in the diagram on page 144.

Ground (Earth) System

The ground (earth) system is a key part of the overall antenna system and consequently the system operation. An inadequate ground (earth) system is the primary cause of poor performance and tuning problems. There is little point in installing the antenna unless a good ground (earth) system or counterpoise can be provided.

Metal hulled vessels provide an almost perfect ground (earth). The tuner ground (earth) terminal should be connected directly to the hull using the shortest possible ground (earth) strap. The point of connection to the hull should be prepared so that it is free of paint and rust to ensure a good contact area with minimum electrical resistance.

Wooden or fibreglass vessels present more of a problem to ground (counterpoise). Ideally the vessel should be fitted with an external copper ground (earth) sheet, connected to the interior of the vessel by suitable stud or an ground (earth) plate ("E" plate Barrett P/N BCA91700)

Should neither of these methods be available it will be necessary to bond as many large metallic objects, such as the engine and propeller shaft, together to form a ground (earth).

Whichever method is used the ground (earth) run from the ground (earth) plate to the antenna tuner should be as short as possible and use copper strap at least 50 mm wide (wider if available). Consideration must always be given to the problem of electrolysis. Severe structural damage may occur if electrolysis is present. Consult your maritime experts for more information concerning electrolysis.

Corrosion

All connections in marine situations are subject to corrosion and oxidation. To minimise this all joints should be cleaned and have silicon grease applied before assembly. Under severe conditions joints should be protected with self vulcanising rubber tape.

Post-Installation Performance Test

After the mechanical installation of the system is complete as per the system diagram:

1. Select the highest frequency to be used on the transceiver.
2. A directional wattmeter should be inserted into the coaxial transmission line between the transceiver and the tuner. If one is not available, the internal metering of the Barrett 4050 Transceiver could be used for this test.

3. Press the TUNE button on the transceiver front panel to begin a tune cycle. This will key the system with modulation and the exciter will provide a low RF level to the tuner for the period of the tune cycle. On detection of this RF energy, the tuner should start to tune, indicated by the 'clattering' of the tuner relays. After a few seconds the relay noise will cease, the transceiver should indicate "Tune OK" and the watt-meter and 4050 front panel should show a low value of reflected power, consistent with a VSWR of better than 2:1.
4. Select the lowest desired frequency on the transceiver and repeat the above procedure. The result should be the same, except that the tune cycle may take somewhat longer.

If the above procedure does not give the results indicated, check that the antenna length and connections are correct and re-check all ground connections. If a successful tune is achieved, the exciter will raise the excitation power to achieve the full output power from the system.

Note: When received, the Barrett 911 automatic antenna tuner memory system will usually not have any pre-stored tuning information appropriate to your installation. To allow the 911 to 'learn' its tuning information simply proceed from one channel to the next allowing the normal tune cycle to take place. Each successful tune is 'memorised' so that when that channel is re-selected, the tuner will almost instantaneously retune to that frequency.

- 1 Barrett 911 Automatic Antenna Tuner (P/N BC91100)
- 2 Antenna
- 3 Feed Through Insulator (P/N BCA91701)
- 4 Ground (counterpoise)
- 5 In-line Fuse
- 6 6 metre power cable supplied with transceiver (P/N BCA40006)
- 7 External GPS Receiver option (P/N BCA40009)
- 8 Coaxial / Control Cable Extension (P/N BCA90055)
- 9 Ground (earth)
- 10 Barrett 4050 HF SDR Transceiver (P/N BC405000)
- 11 Extension speaker supplied with transceiver (P/N BCA40015)
- 12 Microphone (P/N MI-45001)

Installing a Secondary Control Head

The 4050 can support a secondary control head through the IP/AUX Control head port on the rear of the 4050. This secondary head can be purchased on its own from Barrett Communications (P/N BCS40005) and controls the radio in the same manner as the primary. This may be useful in multiple situations such as for security reasons, a secondary head may need to be located in another room; personnel carriers may require a head be accessible for those in the back of the vehicle; or marine installations where a secondary head may need to be away from the primary body.

IMPORTANT NOTE:

THE SECONDARY HEAD IS NOT TO BE CONNECTED WHILST THE TRANSCEIVER IS POWERED UP. THIS MAY CAUSE DAMAGE TO THE TRANSCEIVER.

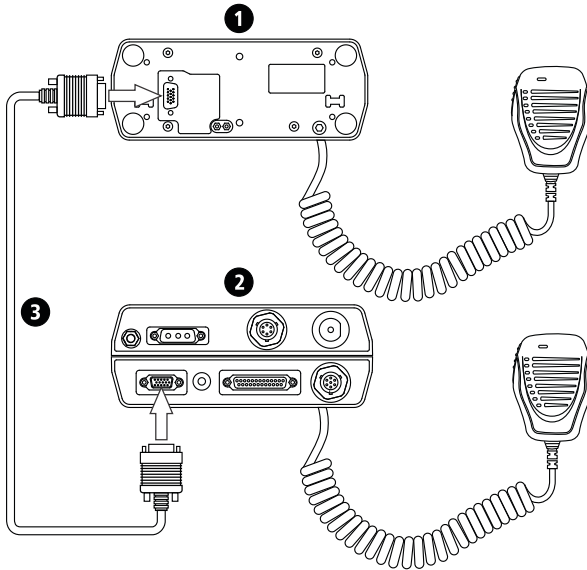

Number	Description
1	4050 Control head (rear) (P/N BCS40005)
2	4050 HF SDR Transceiver (rear)
3	Control Head cable (P/N BCA40005)

Installing Dual Antennas

The 4050 can support a second antenna through the use of a Dual Port Antenna Switch Unit. Two examples of dual antenna use are a mobile unit utilising both a 2019 Automatic Tuning Mobile HF Antenna and a 2018 Mobile Magnetic Loop Antenna, or a base station with one long wire antenna set up North-South with a second long wire set-up East-West.

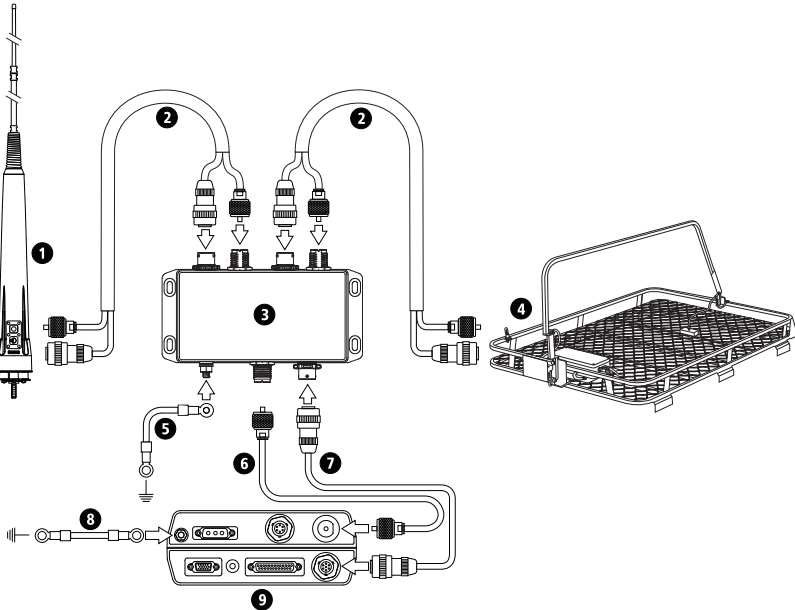

Number	Description
1	2019 Automatic Tuning Mobile HF Antenna (P/N BC201900)
2	2x Control Cable 2019 Antenna to Transceiver 6 metres (P/N 2019-00-02)
3	Dual Port Antenna Switch Unit (P/N BCA40506)
4	2018 Mobile magnetic loop HF antenna (P/N BC201801)
5	Ground (earth)
6	Coax cable (P/N BCA90028)
7	ATU cable (P/N 2065-00-06)
8	Ground (earth)
9	4050 HF SDR Transceiver rear

APPENDICES 8

This chapter contains the following sections:

- Appendix 1- Specifications
- Appendix 2 - Connectors
- Appendix 3 - Overview of HF Operation
- Appendix 4 - BITE Test

Appendix 1 - Specifications

General

Standards	Designed to meet or exceed: FCC - Part 87 and Part 90, FCC no.: OW4-4050HF CE Australian/ New Zealand standard AS/NZS 4770:2000 and AS/NZS 4582:1999 EMC and standard IEC 945 MIL-STD 810G for shock , vibration, dust, temperature, altitude and humidity and IP45 NTIA JITC Industry Canada (IC) RSS-125 Issue 2
Transmit frequency range	1.5 MHz to 30 MHz
Receive frequency range	250 kHz to 30 MHz
Frequency stability	± 0.5 ppm (± 0.1 ppm optional)
Frequency resolution	10Hz Program Mode 1Hz Tunable Receiver
Operating modes	J3E (USB, LSB) - H3E (AM) - J2A (CW) - CF (Custom Filter) - ISB
Filter bandwidth	Fully software defined standard and custom filter range from 300Hz to 3000Hz (6kHz ISB option)
Operating temperature	-30°C to +70°C relative humidity 95% , non-condensing
Frequency hopping	Barrett HF Frequency Hopping algorithms - 25 or 5 hops per second with GPS External Synchronisation Unit (ESU) supplied when the option is fitted. Improved internal clock to maintain clock synch without GPS signal for extended periods in the field (Minimum 48 hrs w/o GPS Signal)

Digital Voice Encryption	Enhanced Digital Voice and Secure Digital Voice options with choice of autobauding "Low Rate" vocoder option (TWELP/MELP Non-proprietary - customisation available) providing superior voice recovery on poor channels down to -3dB. - AES 256 Digital Encryption with 600/1200/2400bps Vocoder - DES 56 Digital Encryption with 700/1200/2400bps Vocoder
Supply voltage	+11 to +28 VDC operation
Selcall system	Based on CCIR 493-4, four and six digit systems. Protocol available for free distribution. Fully compatible with other major HF manufacturers' four and six digit systems including encrypted systems Optional ICAO Annex 10 Selcall Encode (ARINC)
ALE Standards	2G and 3G
Current consumption	350 mA standby (muted)
Channel capacity	Up to 1000 programmable channels (depending on the 4050 variant (simplex or semi-duplex))
Switching speed	<10msec
Weight	2.75 kg (local control configuration)
Width	188 mm
Depth	251 mm (local control configuration)
Height	83 mm

Receiver

Sensitivity	-125 dBm (0.126 μ V) for 10dB SINAD (reduced sensitivity between 250kHz and 500kHz)
Selectivity J3E	-1 kHz and +4 kHz better than 70dB -2 kHz and +5 kHz better than 70dB -5 kHz and +8 kHz better than 75dB
Selectivity J2B (optional)	-500 Hz and +500 Hz better than 60 dB

Blocking	Max usable sensitivity -20kHz and +20kHz: better than 95dB
Intermodulation distortion	Better than 110 dB μ V
Spurious response ratio	Better than 95 dB
Reciprocal mixing	Better than 110 dB μ V (As defined in ITU-R F.612)
In-band IMD	Better than 40 dB
Audio output	4 W into 4 ohm at less than 2% distortion
Audio response	-6dB for 300Hz to 2700 Hz (adjustable bandwidth)

Transmitter

RF output power	150 W PEP Voice (with 24 V supply) 150 W PEP Voice (with 13.8 V supply)
Duty cycle	100% 2 tone input with fan option (-30°C to +50°C relative humidity 95%, non-condensing)
Intermodulation Products	Better than 32dB below PEP (26dB below two-tone peak)
Audio frequency response	Less than 6 dB variation 350 Hz to 2700 Hz
Current consumption	Voice average less than 10 amps typical Two tone less than 12 amps typical 13.8 V DC - Max 20.5A (Full power 125W) 13.8 V DC - Max 20.5A (Full power 150W) 24 V DC - Max 11.5A (Full power 125W) 24 V DC - Max 11.5A (Full power 150W)

Specifications are typical. Equipment descriptions and specifications are subject to change without notice or obligation.

Appendix 2 - Connectors

Note: All connectors described below are viewed looking at the rear of the transceiver.



Power Connector

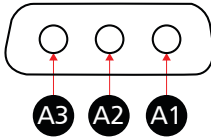

- A1 12 V DC - 28 V DC
- A2 Reserved
- A3 Ground

GPS Connector

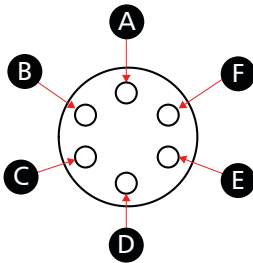

Signal

- A. 1PPS
- B. NMEA+
- C. 5 V GPS
- D. CW Key
- E. GND
- F. Reserved

Level

- 1 Pulse per second
- NMEA Data positive
- GPS Voltage 5 V
- Active Low
- Ground

IP/Aux Control Head

These pins are dependant on hardware revisions. Revisions are marked in the table below as Ax where x is the revision number. The revision number can be viewed under Settings < System Info < Version Information. See page 52 for more information.

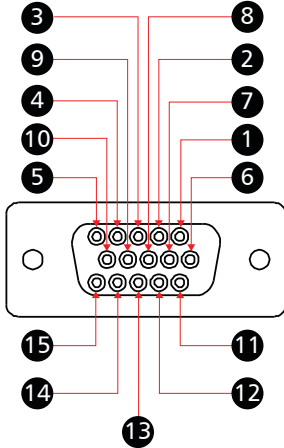

1. VCC
2. CAN Bus positive pin
3. CH Audio+
4. Not Connected
5. Ground
6. Ground
7. CAN Bus negative pin
8. CH Audio-
9. Not Connected
10. Line Out
11. Linear amp ALC for Break out Box
12. 13V8 Out
13. Line In+ (rev. A10 or earlier) USB+ (A11 or later)
14. Line In- (rev. A10 or earlier) USB- (A11 or later)
15. 1PPS (rev. A10 or earlier) USB 5V (A11 or later)

Auxiliary Connector

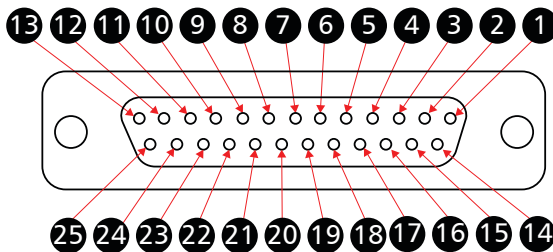

Pin	Name	Description of Function	Level
1	Ground	Ground	0 V
2	Rx Data	RS-232 data input	True RS-232

Pin	Name	Description of Function	Level
3	Tx Data	RS-232 data output	True RS-232
4	Reserved		
5	Reserved		
6	ARINC PTT In	ARINC PTT Input	
7	RS-232 Gnd	RS-232 Ground	0 V
8	Reserved		
9	PTT In	Auxiliary PTT input	Active low 0 V
10	Scan Stop	Scan stop input from external modem	Active low 0 V
11	Bal. Tx Audio In	Balanced Tx audio input (with pin 24)	600 Ω -24 dBm to 0 dBm
12	Bal. Rx Audio Out	Balanced Rx audio output (with pin 25)	600 Ω -6 dBm to +9 dBm
13	Ground	Ground	0 V
14	Reserved		
15	Reserved		
16	Reserved		
17	Reserved		
18	Alarm Out	Selcall alarm	Active low 0 V
19	Mute State Out	Audio mute state	Active low 0 V
20	Reserved		
21	PTT / C-Mute	PTT Out / Receiver Cross Mute	Active low 0 V
22	CW Key In	CW Key input	
23	+13.8 V Fused Out	+13.8 V Output to power auxiliary equipment	13.8 V @ 2 amp
24	Bal. Tx Audio In	Balanced Tx audio input (with pin 11)	600 Ω -24 dBm to 0 dBm
25	Bal. Rx Audio Out	Balanced Rx audio output (with pin 12)	600 Ω -6 dBm to +9 dBm

Note: Balanced Rx audio out on Pin 25 and Pin 12 can be un-muted or follow the audio mute depending on the configuration in the protected menu I/O section.

ATU Connector

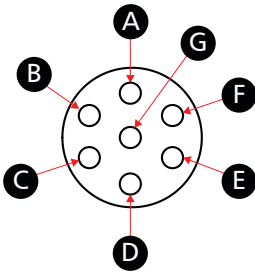

Signal

- A. GND and shield
- B. RS-232 RX / GPS Data
- C. 1PPS
- D. Scan
- E. Tuned
- F. ATU V+
- G. RS-232 TX

Level

- Ground and cable shield
- Receive data line of RS-232
- 1 Pulse per second
- ATU Scan line
- ATU Tuned signal
- ATU Voltage 13V8
- Transmit data line of RS-232

Microphone Connector

Located on the Front Panel.

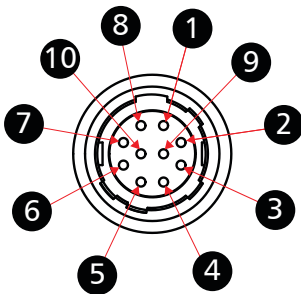

Signal

- 1. MicH
- 2. MicL
- 3. GND
- 4. PTT
- 5. CH UP
- 6. CH DN
- 7. Reserved
- 8. Reserved
- 9. SPKR+
- 10. SPKR-

Level

- Microphone audio high
- Microphone audio low
- Ground
- Low going PTT
- Channel up
- Channel down
- Reserved
- Reserved
- Speaker microphone positive
- Speaker microphone negative

Control Head Rear Panel Connector

Plug located on the rear of the Front Panel.

These pins are dependant on hardware revisions. Revisions are marked in the table below as Ax where x is the revision number. The revision number can be viewed under Settings < System Info < Version Information. See page 52 for more information.

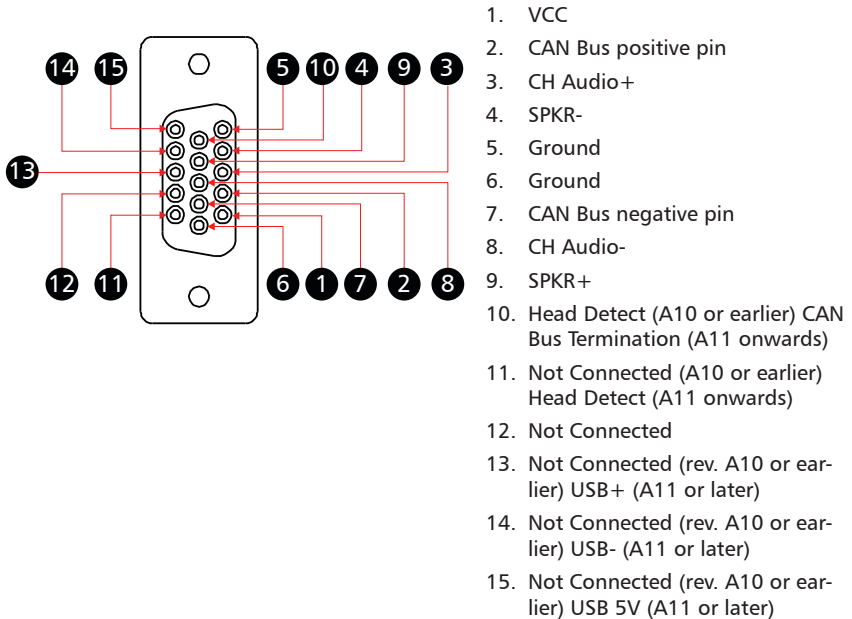

Cooling Fan Connector

Socket located on the top of the SDR.

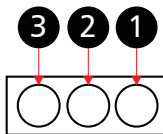

(Viewed from the rear of the SDR)

1. Ground
2. + 12 V DC
3. Fan detect

Appendix 3 - Overview of HF Operation

HF (High Frequency) is the radio spectrum with frequencies between 1.6 and 30 MHz. Within this radio spectrum an efficient form of transmitter modulation, SSB (Single Side Band), is used. This, combined with the use of the ionosphere - a layer of ionisation gases that resides between 100 and 700 km above the Earth's surface, provides efficient, cost effective communications over short, medium and long distances - without the need for expensive re-transmission devices, such as the VHF or UHF repeaters or satellites, all of which have ongoing operational costs and a reliance on a physical infrastructure.

In many remote areas, HF / SSB is the only form of communication possible.

HF Propagation

When HF / SSB radio waves are generated by the transceiver there are usually two components:

- The ground-wave, which travels directly from the transmitting antenna to the receiving antenna following the contours of the Earth.
- The sky-wave, which travels upward and at an angle from the antenna, until it reaches the ionosphere (an ionised layer high above the Earth's surface), and is then refracted back down to Earth, to the receiving antenna.

Generally speaking, ground-wave is used to communicate over shorter distances usually less than 50 km. Because ground-wave follows the contours of the earth, it is affected by the type of terrain it passes over. Ground wave is rapidly reduced in level when it passes over heavily forested areas or mountainous terrain.

Sky-wave is used to communicate reliably over medium to long distances up to 3,000 km. Whilst the nature of sky-wave propagation means it is not affected by the type of terrain as in ground-waves, it is affected by factors involving the ionosphere as described below.

Radio Wave Propagation

The following illustrations show the characteristics of ground-wave and sky-wave propagation during day and night time. In each illustration the height of the ionosphere above the ground is shown.

In both illustrations Station A communicates with Stations B, C and D. Propagation from Station A to B is by ground-wave. The diagrams illustrate that the ground-wave is not affected by the time of day and the height of the ionosphere above the ground.

Propagation from Station A to C and D, is by sky-wave and as the diagrams illustrate, the sky-wave is significantly affected by the time of day and the height of the ionosphere above the ground.

Under each diagram there are recommended working frequencies listed. Please note that these will vary according to time of year and other factors. They are intended only as a guide and are subject to change.

Day

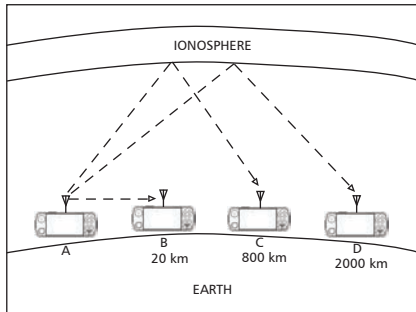

- The sun is higher
- The ionosphere is higher
- The best frequency to use is higher.
- A to B - Possible optimum working frequency is 3 MHz
- A to C - Possible optimum working frequency is between 7 - 9 MHz
- A to D - Possible optimum working frequency is between 13 - 16 MHz

Night

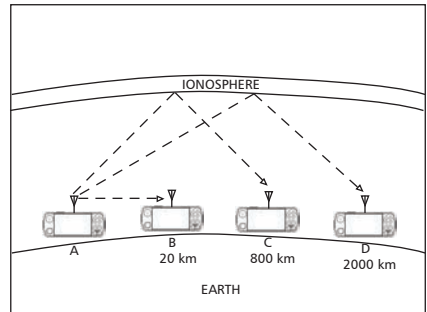

- The sun is lower
- The ionosphere is lower
- The best frequency to use is lower.
- A to B - Possible optimum working frequency is 3 MHz
- A to C - Possible optimum working frequency is between 5 - 7 MHz
- A to D - Possible optimum working frequency is between 9 - 12 MHz

Factors Which Affect HF/SSB Communications

There are a number of different factors which will affect the success of communications via HF/SSB radio. These are outlined below:

Frequency Selection

Frequency selection is perhaps the most important factor that will determine the success of your HF/SSB communications.

Generally speaking the greater the distance over which you want to communicate, the higher the frequency you should use.

Beacon Call, a Selcall (Selective Call) function built into the Barrett 4050 Transceiver, makes finding the correct frequency to use easy. A Beacon Call is based on the network of transceivers all having a selection of frequencies that will accommodate most ionospheric conditions. When in standby, the network transceivers scan these frequencies waiting for a call (Selcall or Beacon Call) from another transceiver. The transceiver wishing to check for the best frequency to operate on sends a Beacon Call to the station to be contacted. If the call to the other station is successful, a revertive tone from the station being called will be heard, indicating the channel selected was suitable for the ionospheric conditions prevailing. If the revertive tone is not heard or is very weak, another channel may be tried until a revertive tone of satisfactory signal strength is heard.

(Refer to Beacon Calls on page 30 for more details.)

Time of Day

As a rule, the higher the sun, the higher the frequency that should be used. This means that you will generally use a low frequency to communicate early morning, late afternoon and evening, but you will use a higher frequency to cover the same distance during times when the sun is high in the sky (for example, midday). You will need to observe the above rule carefully if your transceiver has a limited number of frequencies programmed into it, as you may only be able to communicate effectively at certain times of the day.

Weather Conditions

Certain weather conditions will also affect HF/SSB communications. Stormy conditions will increase the background noise as a result of static caused by lightning. This background noise could rise to a level that will blank out the signals you are trying to receive.

Man-made Electrical Interference

Interference of an electrical nature can be caused by overhanging power lines, high power generators, air-conditioners, thermostats, refrigerators and vehicle engines, when in close proximity to your antenna. The result of such interference may cause a continuous or intermittent increase in the level of background noise.

System Configuration and Installation

The method in which your system is configured and installed will also affect the success of your HF/SSB communications. Your choice of antenna system and power supply is critical. Correct installation is also extremely important. An HF/SSB transceiver is generally installed using different rules to those used to install VHF or UHF transceivers. Failure to correctly install an HF/SSB system will greatly affect the communications quality you will obtain.

Your local Barrett representative will be able to assist with your system configuration and/or installation.

HF Communications Compared with VHF or UHF Short Distance Communications

Communications on any HF/SSB transceiver will sound different to that on a VHF (Very High Frequency) radio or UHF (Ultra High Frequency) radio or telephone. This is because of the nature of HF propagation and the modulation methods used. On HF/SSB transceivers there will always be background noise evident behind the signal you are receiving and this will increase when there is electrical interference or thunderstorm activity in the area.

Appendix 4 - BITE Test

It is recommended that any accessories (ATU, linear amplifier, Dual Antenna Switch Unit, secondary control head, GPS etc.), auxiliary port connections and the antenna be disconnected from the SDR to get consistent BITE test results. Additionally do not touch the control head and the microphone buttons while the tests are running.

Each test is outlined below as are possible causes for a failed result. If the fault is interfering with the everyday operation of the system, please contact your local Barrett dealer or Support at www.barrettcommunications.com.au.

Tests

Real Time Clock

This test checks if the real time clock on the microboard responds to commands. A failed test indicates an issue with the I2C bus on the **microboard** or a defective real time clock.

Pre Amplifier I/O

This test checks if the pre amplifier board is accessible by checking if the port expander responds to commands. A failed test indicates an issue with the I2C bus on the **microboard**, the **pre amplifier board** or a **loose connector** between the two transceiver halves.

Rear I/O

This test checks if the rear interface board is accessible. A failed test indicates an issue with the I2C bus on the **microboard**, the **rear interface board** or a **loose connector** between the two boards.

Local Oscillator

This test checks if the oscillator on the microboard is accessible. A failed test indicates an issue with the SPI bus on the **microboard** or a defective oscillator.

Audio Codec

This test checks if the audio codec on the microboard is accessible. A failed test indicates an issue with the I2C bus on the **microboard**, a failed DSB bootup, an ISP bus issue to the DSP or a defective audio codec.

Analog to Digital Converter

This test checks if the A/D converter for measuring the final stage voltage is accessible. A failed test indicates an issue with the I2C bus on the **microboard**, the **pre amplifier board**, a **loose connector** between the two transceiver halves or a defective A/D converter.

Temperature Sensor

This test checks if the temperature sensor for measuring the final stage temperature is accessible. A failed test indicates an issue with the I2C bus on the **microboard**, the **pre amplifier board**, a **loose connector** between the two transceiver halves or a defective temperature sensor.

Digital to Analog Converter

This test checks if the D/A converter for controlling the boost converter is accessible. A failed test indicates an issue with the I2C bus on the **microboard**, the **pre amplifier board**, a **loose connector** between the two transceiver halves or a defective D/A converter.

Rx Current

This test checks if the overall current draw while in receive mode (idle) is below 1A. This test can fail if too many accessories (Dual Antenna Switch Unit, ATU, linear amplifier etc) are connected to the SDR or if the accessories are faulty. Disconnect all accessories and rerun the tests. If the test is failed again, there is an issue with the **pre amplifier board**.

Tx Current

This test checks if the overall current draw while in transmit mode (BIAS current added) is between 1A and 4A. A failed test indicates the same issues as with the "Rx Current" test. Additionally, there may be an issue with the final stage on the **pre amplifier board**.

Final Voltage

This test checks if the voltage of the final stage is between 28V and 32V. A failed test indicates a defective **pre amplifier board** (port expander fails to configure the pre amplifier board, the D/A converter fails to set voltage, the boost converter fails or the A/D converter fails to read the voltage).

EEPROM

This test checks if the EEPROM allows read/write access. A failed test indicates a faulty EEPROM on the **microboard**.

Rx Test

This test checks the receiver chain with a synthetic signal. A failed test indicates a defect on the **microboard** (e.g. synthesizer, digital IF, etc).

Automatic Gain Controller

This test cycles through the attenuators and checks if the AGC adjusts itself accordingly. A failed test indicates a defect on the **microboard** (e.g. attenuators).

Warranty Statement

Barrett Communications (hereafter referred to as 'Seller') provides a three (3) year warranty on all Barrett products from the date of shipment from the Seller. A one (1) year warranty from the date of shipment from the Seller is provided for all batteries.

Each warranty guarantees acceptable performance of the product under normal recommended conditions for the duration of the warranty period. In cases of accident, abuse, incorrect installation or maintenance by a non-Seller representative, subjection to abnormal environmental conditions, negligence or use other than those in accordance with instructions issued by the Seller, the warranty shall be voided. In addition, this warranty shall not cover low performance – specifically the distance or quality of transmission and reception - due to unfavourable environmental or locational conditions. Nor shall this warranty cover the quality of transmission and reception of transceivers mounted in vehicles or vessels that have not been sufficiently electrically suppressed.

Should any fault due to bad design, workmanship or materials be proven at any time within the warranty period, the Seller will rectify such fault free of charge provided that the equipment is returned, freight paid, to Barrett Communications Pty Ltd head office or to an authorised service centre. The repaired or replaced product will remain covered under and throughout the term of the original warranty period up to its expiration. No repair or replacement will extend the warranty term past the original thirty-six (36) month anniversary of the original date of shipment from the Seller.

Firmware and software (pre-installed, stand-alone or provided as an update), hereafter referred to as 'Software', is guaranteed to perform acceptably within the specifications provided by the Seller, provided that the Software is within the warranty period.

Should Software not perform acceptably, the Seller will use all commercially reasonable efforts to correct such nonconformity as reported to the Seller directly or via a support representative. The Seller is not obliged to update Software under warranty if the nonconformity is caused by a) the use or operation of the Software in an environment other than intended or recommended by the Seller in relevant documentation, or b) modifications made to the Software not authorised or undertaken by the Seller or a representative of said Seller.

Subject to the matters set out in this warranty, no liability, expressed or implied is accepted for any consequential loss, damage or injury arising as a result of a fault in the equipment and, all expressed or implied warranties as to quality or fitness for any purpose are hereby excluded.

This warranty does not extend to products supplied by the Seller which are not designed or manufactured by it. The Seller will however make every

endeavour to ensure that the purchaser receives full benefit on any warranty given by the original equipment manufacturer.

This warranty is restricted to the original purchaser except where the original purchaser is a reseller authorised by the Seller who has purchased for the purpose of resale, warranty shall be extended to the reseller's customer.

Contact Details

Our customer / dealer technical support department can be contacted via land mail, email, telephone or via support ticket on the technical support web page.

<https://www.barrettcommunications.com.au/support/>

Barrett Communications Pty Ltd Head Office:

PO Box 1214, Bibra Lake WA 6965 AUSTRALIA

Toll Free Tel: 1800 999 580 (Within Australia)

Tel: +618 9434 1700

Fax: +618 9418 6757

email: support@barrettcommunications.com.au

Telephone support from the Australian office is available from 7:30 am to 4:00 pm local time Monday to Friday.

Barrett Communications – Europe:

Unit 9, Fulcrum 2 Victory Park, Solent Way,
Whiteley Hampshire PO15 7FN United Kingdom

Tel: +44 (0) 1489 880 332

Fax: +44 (0) 1489 565 422

email: support@barrettcommunications.co.uk

Telephone support from the UK office is available from 8:30 am to 5:00 pm local time Monday to Friday.

Barrett Communications Corporation USA:

90 Office Parkway
Pittsford, N.Y. 14534

Tel: +1 585 582 6134

email: support@barrettusa.com

Telephone support from the USA support office is available from 8:30 am to 5:00 pm local time Monday to Friday.

Index

A

- Advanced Call History 35
- All call 67
- Antenna
 - 911 Automatic Antenna Tuner 106
 - Connection Details (Marine) 134
 - 912 Multi wire Broadband Dipoles 96
 - 2019 Automatic Tuning Mobile Antenna 118
 - Assembly 124
 - Connection Details (Mobile Pack) 118
 - Mounting 120
 - 4011 Automatic Antenna Tuner for Base Station 101
 - Connection Details 104
 - 4017 Automatic Tuning Horizontal Dipole 98
 - Connection Details 99
 - Noise Suppression 116
- ARINC 4, 24, 27, 63, 64
- ATU Connector 146
- Audio 49, 53, 63, 65, 66, 74, 81, 141, 142, 144, 145, 147
 - Mute 74
- Auxiliary Connector 144

B

- Base Station 15, 72, 89, 91, 101, 104, 106, 109
- Battery Backup Configuration 93
- Beacon Call 22, 24, 30, 31, 40, 42, 43, 44, 45, 81, 150
- BoB 9, 71, 72, 144
- Break out Box 3, 7, 71, 72, 144

C

- Call History 4, 29, 32, 34, 35
- Call History Menu 35
- CCIR 4, 22, 23, 24, 47, 141
- Channel labels 58
- Collective Call 63, 67

Configuration 13, 14, 61, 62, 65, 104, 109, 151

Connectors

ATU 146

Auxiliary 144

Control Head 144

Control Head Rear Panel 147

GPS 143

Microphone 146

Power 143

Contacts 21, 26, 28, 29, 30, 31, 33, 40, 42, 43, 44, 46

Control Head Connector 144

Control Head Rear Panel Connector 147

Cooling Fan

Connector 147

D

Digital Voice 63, 66, 68, 86, 87, 95

Display 1, 4, 9, 49, 54

Dual Port Antenna Switch Unit 71, 72, 137

E

Earth 102, 107, 132, 148

Emergency Call 13, 18, 19, 24

Export 61, 68, 69

F

Frequency Hopping 4, 63, 69

Front Panel 6, 7

G

General Configurations screen 50, 52

GPS Connector 143

GPS Position 43

GPS Push 70

GPS Request 41

Ground 14, 66, 94, 100, 102, 105, 107, 110, 119, 123, 130, 132, 135, 143,
144, 145, 146, 147, 148

Group call 67

H

Hangup 33, 46

Hopping 4, 63, 69, 86

I

Import 62

INT 4, 22, 23, 25, 40, 47

I/O 15, 63, 70, 71, 145

L

Label 9, 58, 59

M

Marine Installations 131

Microphone Connector 146

Mobile Installations 89, 111

Mobile Pack 111

Mode 59, 87

Mounting 99, 101, 106, 114, 116, 120, 124, 126, 127, 128, 131

Mute 63, 66, 74, 75, 145

 Audio 74

 Syllabic Sensitivity 74

N

Network 5, 47, 48, 59, 63, 76

Noise Reduction 63, 78

Noise Suppression 116, 117

O

OEM 4, 22, 23, 24, 25, 40, 47, 86

P

Pagecall 22, 40, 41

 Receive 41

Power Connector 143
Programming 11, 18, 55, 56, 61, 67, 87

R

RF 5, 63, 79, 80, 91, 101, 103, 107, 120, 132, 142
RFDS 5, 18, 22, 47
RS232 71, 72

S

Scan 5, 81, 82, 83, 84, 145, 146
Scan Table 5, 82, 84
Secure Call 24, 45, 87
Secure Digital Voice 68, 86
Security 45, 63, 69, 85, 86
Selcall 2, 4, 5, 11, 18, 19, 21, 22, 23, 24, 25, 27, 29, 30, 31, 32, 33, 34, 35,
39, 41, 42, 44, 46, 47, 48, 64, 67, 72, 74, 81, 83, 84, 141, 145, 150
Selcall ID 25, 27, 33, 34, 41, 42, 44, 46, 67
Selcall Mute 74
Self ID 5, 21, 23, 25, 34
Self IDs 23
Serial Number 50, 51
Specifications
 Receiver 141
 Transmitter 142
SSL Mute 74
Status Call 44
Sub-group Call 67
Swipe Menu 10

T

Telcall 2, 5, 22, 24, 30, 32, 33, 34
Transceiver
 Front Panel 6, 7
Tuning 63, 88, 98, 99, 101, 118, 119, 120, 125, 126

V

Version Information 50
Voice Call 13, 17
Voice Mute 74, 75
VSWR 88

Head Office:

Barrett Communications Pty Ltd
47 Discovery Drive, Bibra Lake, WA 6163 Australia
Tel: +61 8 9434 1700 Fax: +61 8 9418 6757
Email: info@barrettcommunications.com.au
www.barrettcommunications.com.au

Europe:

Barrett Communications - Europe
Unit 9, Fulcrum 2, Solent Way, Whiteley, Hampshire, PO15 7FN United Kingdom
Tel: +44 (0) 1489 880 332 Fax: +44 (0) 1489 565 422
Email: uksales@barrettcommunications.co.uk

USA:

Barrett Communications USA LLC
90 Office Parkway, Pittsford, NY 14534 United States of America
Tel: +1 585 582 6134
Email: sales@barrettusa.com